

BS-3520

Digital Indicator

INSTRUCTION MANUAL



BONGSHIN
LOADCELL

The Better Way for Weighing & Measurements

Table of Contents

1. Introduction	3
1-1 Trait	3
1-2 Warning	4
2. Specification	5
3. External Size	6
4. Description on Front Panel	7
5. Description on Rear Panel	9
5-1 Description on Each Terminal Unit.....	9
5-2 How to Use Terminal Block and Replace Fuse.....	12
6. Calibration	13
6-1 Calibration Mode	13
6-2 Digital Calibration Mode.....	14
6-3 Actual Load Calibration Mode.....	16
6-4 Linearization Calibration Mode	18
6-5 Digital Zero Calibration Mode	21
7. Function Mode	24
7-1 Function Setting Method.....	24
7-2 Function Items	25
8. HOLD	30
8-1 Hold Mode.....	30
8-2 Hold Type	32
8-3 Hold Operation	33
9. Relay Mode	35
9-1 Relay Mode	35
9-2 Relay Comparator Mode.....	38
9-3 Comparator Hysteresis Function.....	41

10. Analog Output.....	45
10-1 Analog Output Mode	45
10-2 Analog Output Specification and Connection Method.....	46
10-3 Analog Output Zero and Span Calibration.....	47
10-4 Analog Output Zero and Span Minute Calibration.....	49
11. BCD Output.....	51
11-1 BCD Parallel Output	51
12. Serial Output.....	52
12-1 RS-232C/422/485 Serial Interface	52
12-2 Format	54
13. Check Mode	59
13-1 Operation for Each Check Mode.....	59
14. Key Lock Mode	62
14-1 Key Lock Method	62
14-2 Key Lock Cancellation Method	62
15. Repair	63
15-1 Error Message	63
15-2 Load Cell Inspection	63
15-3 Load Cell Access Diagnosis.....	64
15-4 Pattern of Display Letters	64
16. Warranty and A/S	65

1. Introduction

Thank you very much for purchasing this product.

This product is a model adequate for weighing and measurement system.

This equipment is a product equipped with abundant function and various external interface functions to accommodate diverse wants of user and user can easily use this product with easy handling.

All functions can sufficiently be utilized if you thoroughly read the manual before use.

1-1 Features

BS-3520 is high precision high speed indicator of 96x96mm size.

- High precision 24bit Sigma-Delta A/D converter
- High speed A/D and D/A conversion of 2000 time/sec
- A/D external resolution 1/20,000
- Actual load or digital calibration
- Linearity Compensation Function (4 point excluding zero)
- External display of min/max setting value
- Low, OK, and High relay contact output
- Hold or Peak-hold function
- Basic equipment of Serial Output (RS-232C & RS-422/485)
- Change in relay setting value is available through communication (max. 32 ID)
- Sensor output check function (failure inspection)
- Analog output insulation (option 1, 2)
- Free Voltage Power (AC 85~240V)

1-2 Warning

- Check whether or not there was damage in product during the delivery.
- Do not drop or exert server impact on the product.
- Front panel control button is operated with light touch thus do not exert excessive strength.
- Do not use or store product at location with severe temperature change if possible. (-10°C ~ +50°C)
- Do not install the product at location with severe electric noise and vibration.
- Turn off the power switch before connecting peripherals.
- Grounding of equipment shall be conducted in order to prevent electric noise and fall.
- Exertion of voltage or current over maximum allowable value will lead to damage in the product.
- Power voltage shall be set within allowable range.
Use outside allowable range may cause fire, electric shock, and defect.
- Please understand the fact that contents of manual may be changed without in advance notice.
- Please directly contact the agency or our company regarding the inquiries to the contents of manual.
- Please store the manual at location where it can be seen at any time after reading the manual.

2. Specification

Load Cell excitation	DC 5V, 60mA (350Ω x 4 load cells can be connected)	
Min. Input Sensitivity	0.2μV /Digit (min.)	
Non-linearity	0.01% F.S. max.	
Analog Input Signal Range	-34 mV ~ +34 mV	
Temperature drift	Zero: ±0.1μV/°C RTI max. SPAN: 10ppm/°C max.	
Input Noise	±0.3μVpp or less	
Input Impedance	10MΩ or more	
A/D Internal Resolution	24 bits	
Max. Display Resolution	1/20,000	
A/D Sampling Speed	2,000 times/sec	
Display	Measurement	7-Segment red LED, 6-Digits 14.1mm high 6digit
	High / Low	7-Segment red LED, 5-Digits 8.0mm high 5digit
Range of Max. Display	(-) 19999 ~ (+) 19999 (min gradation: 1) (-)199950 ~ (+)999950 (min gradation: 50)	
Display Conversion Speed	1,000 times/sec ~ 1 time/sec	
Polarity indication (-)	“-“ minus sign	
Annunciators	LO, OK, HI, HOLD, ZERO	
Display increments	1, 2, 5, 10, 20, 50 selectable	
Decimal Point Location	0, 0.0, 0.00, 0.000, 0.0000 (selectable to any points)	
Power Source	AC 85~240V, 50/60Hz (Free Voltage)	
Power Consumption	Approx. 20VA	
Range of Use Temperature	-10°C ~ +50°C	
Basic Output	0) Relay 3CH Output & Serial Output (RS-232C & RS-422/485)	
Option Output	1) DC 0 ~ ±10V Isolated Analog Output (Conversion into DC 0 ~ ±5V is available by user) 2) 4 ~ 20mA Isolated Analog Output (Conversion into DC 0 ~ 20mA is available by user) 3) BCD Parallel Output	
Product Weight	About 700 g	



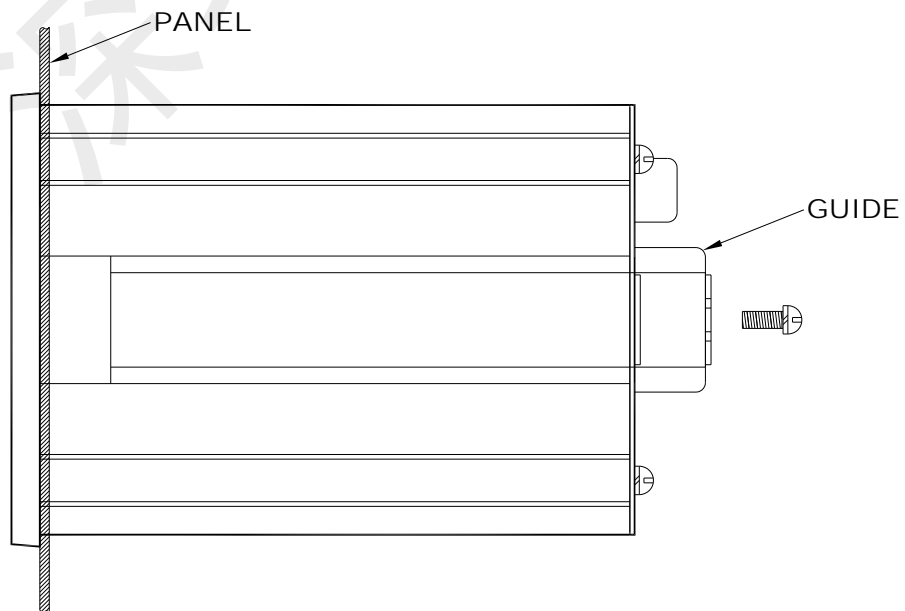
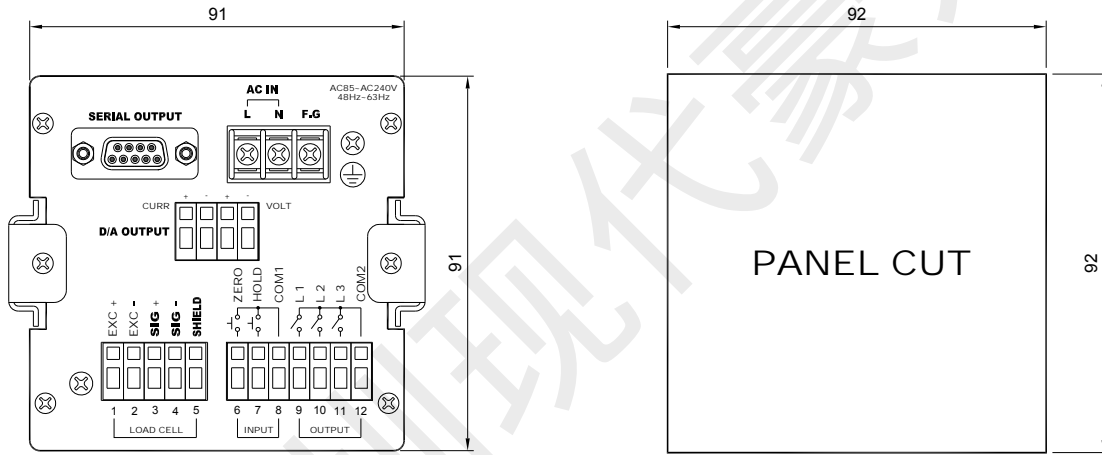
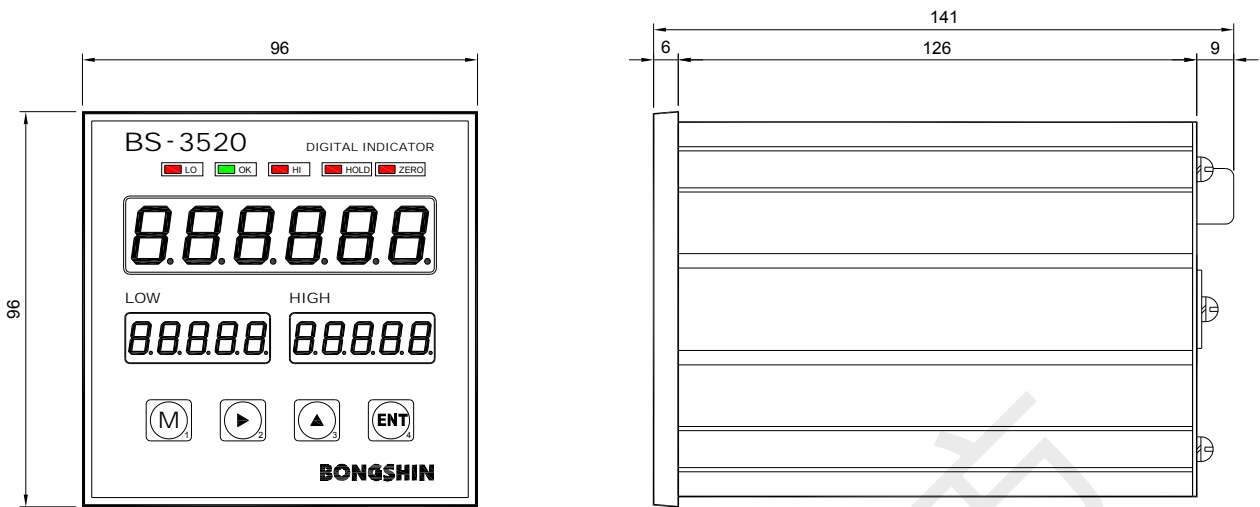



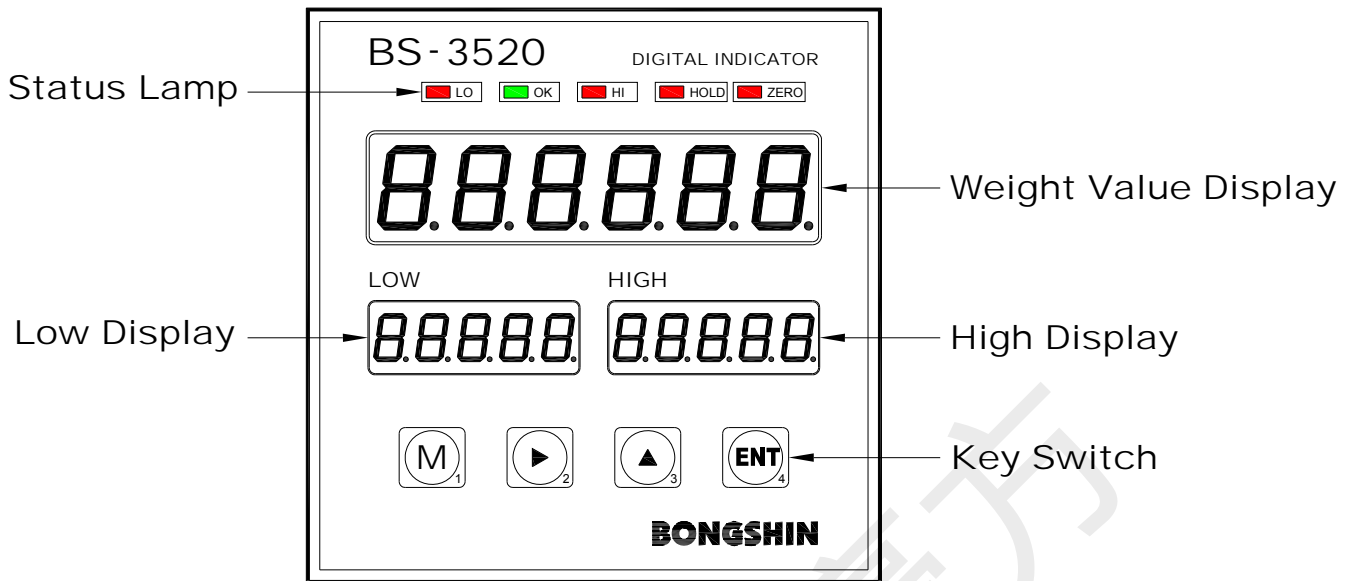





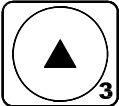

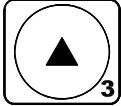

3. External Size



4. Description on Front Panel



Weight Value Display	Display of measurement data and setting value is conducted. Setting of decimal point is conducted at function mode.
Min/Max Display	Min/Max setting value is displayed. Item and setting value are displayed from function mode.
Status Lamp	<p>LO : It flickers when measurement value is under min. setting value. It flickers when it is lower or higher than RY1 relay setting value.</p> <p>OK : It flickers when low value \leq measurement value \leq max value. It flickers when it is lower or higher than RY2 relay setting value.</p> <p>HI : It flickers when measurement value exceeds max setting. It flickers when it is lower or higher than RY3 relay setting value.</p> <p>HOLD : It flickers when hold is conducted.</p> <p>ZERO : It flickers when measurement value is 0 (zero).</p> <p>Peak HOLD : Turns on when the hold function is started. Edge HOLD : Turns on when the value is being held.</p>

Key Switch	
	<p>It is used when entering user setting mode from measurement mode. It is used when exiting to measurement mode from user setting mode. (ESC function)</p>
	<p>It is used as location shift key when entering numerical value of user setting mode. It is used as calibration mode entry key It is used as check mode entry key</p>
	<p>It is used as a key to increase and decrease the numerical value of selected number line of user setting mode. It is used as calibration mode entry key It is used as check mode entry key</p>
	<p>It is used when shifting to next menu from user setting mode. It is used to save or exit after entering various setting values. It is used as calibration mode entry key.</p>
 + 	<p>It is used for zero setting. (No.3 key while pushing No.4 key or No.,4 key while pushing No.3 key)</p>
 + 	<p>It is used when entering function mode. (No. 3 key while pushing No.1 key or No.1 key while pushing No. 3 key)</p>
 + 	<p>It is used when entering calibration mode. (No.3 key while pushing No.,2 key or No.,2 key while pushing No.,3 key)</p>
 + 	<p>It is used when entering relay setting mode. (No.2 key while pushing No.1 key or No.1 key while pushing No.,2 key)</p>
 + 	<p>It is used when entering hold mode. Hold is cancelled when pushing this key once again. (No.1 key while pushing No.4 key or No.4 key while pushing No.1 key)</p>
 + 	<p>It is used for key Lock or unlock. Lock/ unlock is repeated ever time you push this key. (No.2 key while pushing No.4 key or No.4 key while pushing No.2 key)</p>
<p>Power OFF</p>  +  <p>Power ON</p>	<p>It is used when entering check mode. Turn the power on when pushing two keys at once after turning off the power (No.2 key and No.3 key at once)</p>

It does not matter whether you push one key before another or two keys at once in case of mode to enter by pushing two keys.

5. Description on Rear Panel

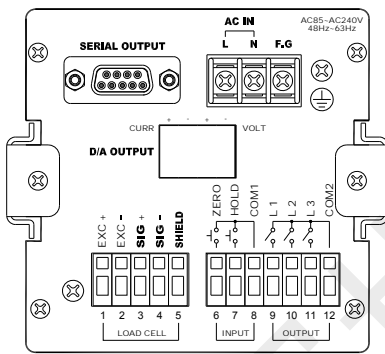
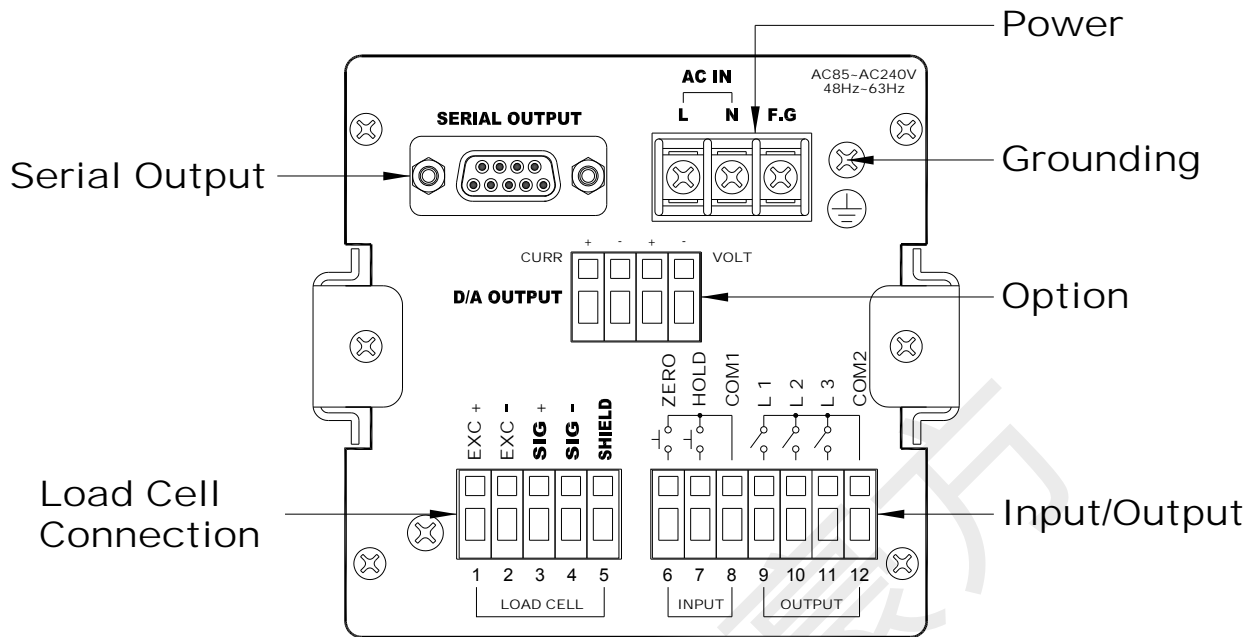

[Standard Specification]

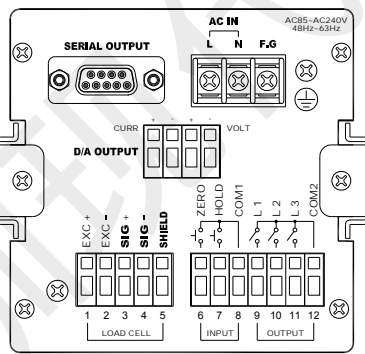

[Analog Output Option]

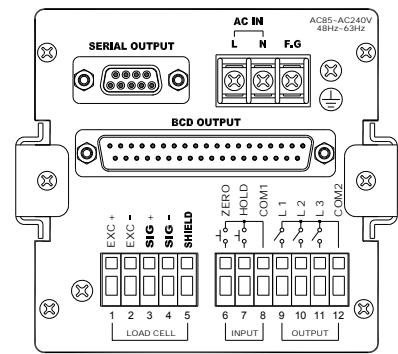

[BCD Output Option]

5-1 Description on Each Terminal Unit

5-1-1 Power (AC IN)

Terminal No.	Name	Contents
L	AC IN	Power Input Terminal
N	AC IN	Power Input Terminal
F.G	Frame Ground	Frame Ground

Access to AC power code is conducted. Input power is **AC85~240V and 50/60Hz**.

5-1-2 LOAD CELL Connection (1) (2) (3) (4) (5)

Terminal No.	Name	Contents
1	EXC +	Load Cell Voltage (+), Red wire
2	EXC -	Load Cell Voltage (-), White wire
3	SIG +	Load Cell Input Voltage (+), Green wire
4	SIG -	Load Cell Input Voltage (-), Blue wire
5	SHIELD	Load Cell Grounding

LOAD CELL

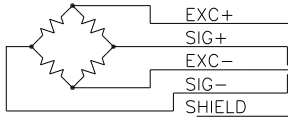

Warning

- Load cell output is very weak thus load cell cable shall be separated and then installed.
- Please use shield cable for load cell cable.
- In case of extending the load cell cable, use of load cell cable of our company is recommended.
- Shield cable of load cell cable shall be connected to BS-3520 terminal only.

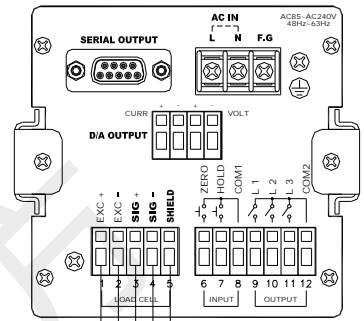

Summing Box

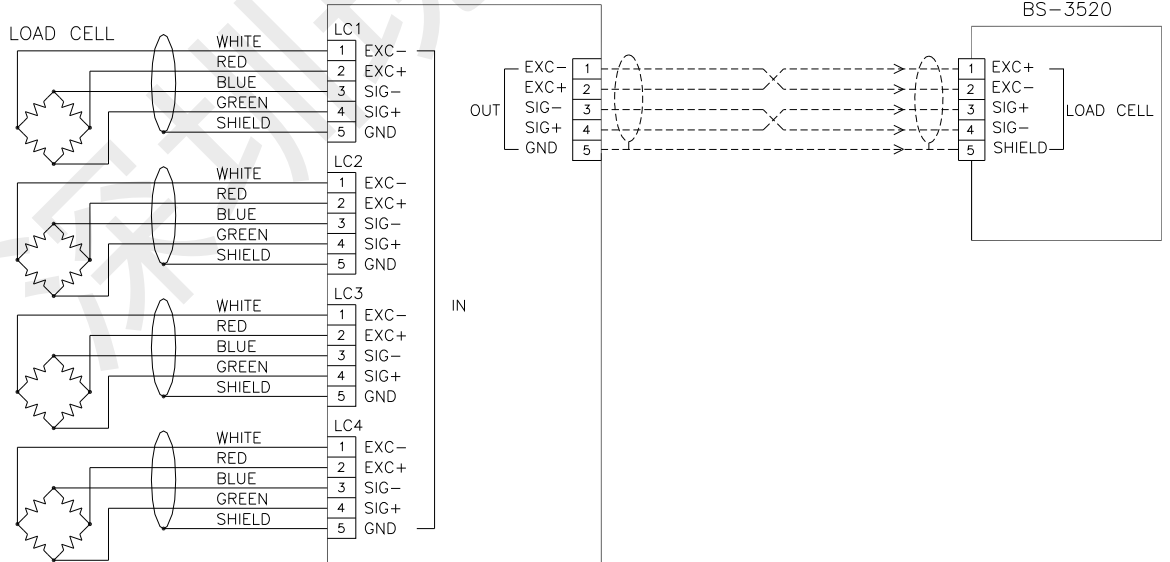

- In case of sealing, load cell input cable SIG+ (green) and SIG- (blue) cable shall be connected to No.4 and No.3 respectively.
- **There may be abnormality in relay operation and option output when the weight is displayed in (-) value.**
- Please check whether or not color of cable for each manufacturer's and load cell model is different or not before the connection.

5-1-3 Input (6) (7) (8)

Terminal No.	Name	Contents
6	ZERO	Control terminal of zero function Valid from COM1 terminal and short circuit (or on coin)
7	HOLD	Control terminal of hold function Valid from COM1 terminal and short circuit (or on coin)
8	COM1	Common terminal of external control

Relay contact or switch or contactless switch such as Open collector output shall be used.

Arbitrary point hold is conducted at the point of granting external contact point.
Hold is cancelled when grating the contact point.

PK hold only holds max value during the time contact point is granted and it is cancelled when contact point is not granted.

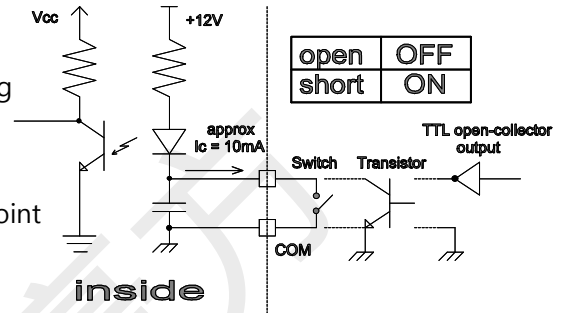

open	OFF
short	ON

TTL open-collector output

5-1-4 Output (9) (10) (11) (12)

Terminal No.	Name	Contents
9	L1	LO (RY1) relay output terminal (a, b contact point output based on mode setting)
10	L2	OK (RY2) relay output terminal (a, b contact point output based on mode setting)
11	L3	HI (RY3) relay output terminal (a, b contact point output based on mode setting)
12	COM2	Common terminal for relay output

Output method differs based on relay mode setting.
Refer to relay operation mode.



- Relay contact point capacity is 5A 250VAC, 5A 30VDC.

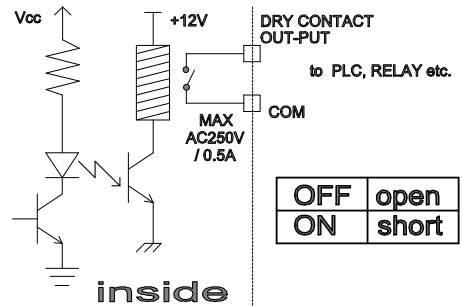

OFF	open
ON	short

5-1-5 Serial Output

They are RS-232C/ RS-422/ RS-485 output port. (basic equipment)

5-1-6 Option (DAC/BCD OUTPUT)

They are Analog Output DC 0~±5V, 0~±10V, DC 0~20mA, 4~20mA output terminal.
(Selection from function mode)

BCD Parallel Output, Analog Output option is equipped upon selection.



- BCD Parallel Output option and Analog Output option cannot be equipped at the same time.

5-2 How to Use Terminal Block and Replace Fuse

5-2-1 How to use terminal block

- 1) Peel off the sheath at the end of cable.

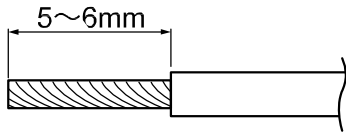

- 2) Terminal is opened when putting driver inside the terminal opening device (top of terminal) and push upward.

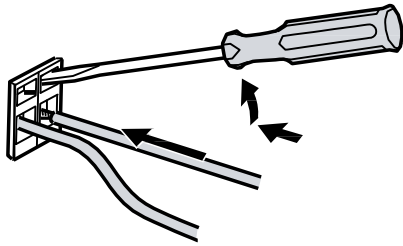

- 3) Terminal is fastened when inserting the cable and pulls back the driver.

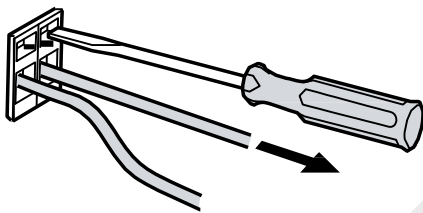

- Forced entry of cable to terminal may cause the damage of terminal.
- Do not insert cable to top of terminal to insert driver.

5-2-2 How to replace fuse

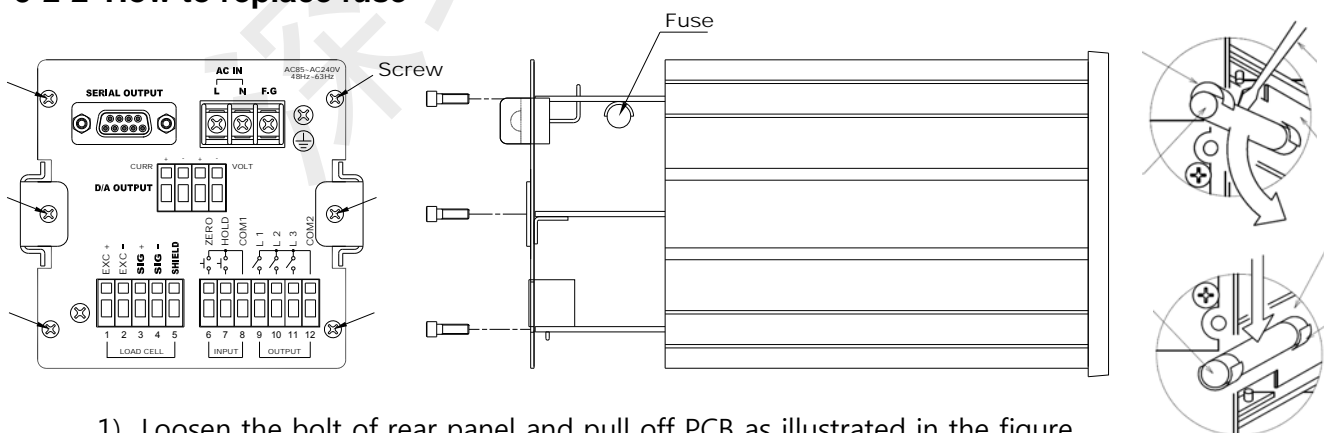

- 1) Loosen the bolt of rear panel and pull off PCB as illustrated in the figure.
- 2) Replace the fuse. (Fuse Capacity: 250V 1.0A 20mm)
- 3) Assembly shall be conducted in reverse of disassembly.



Warning

- It shall be conducted only when the power is turned off.

6. CALIBRATION







There are 3 types of calibration mode.

6-1 Calibration Mode

6-1-1 Mode

- Digital calibration mode **d-CAL**
Calibration shall be conducted not by using the actual load but entering rated output and rated capacity of sensor with key.
- Actual load calibration mode **A-CAL**
It is calibration mode to adjust zero and span with the use of actual load.
- Linearization calibration mode **L-CAL**
It is calibration mode to conduct non-linear calibration that reduces the measurement error through calibration of maximum 4 points excluding zero with the use of actual load

6-1-2 How to select calibration mode

1. It turns into the mode selection status when  key is pushed while pushing  key is pushed at measurement status.
2. Mode change and setting value change is available when  key or  key is pushed at mode selection status.
3. Push  key in order to move onto next stage after saving the setting value at mode selection status.
3. Push  key to cancel the setting and return to measurement mode for mode cancellation.

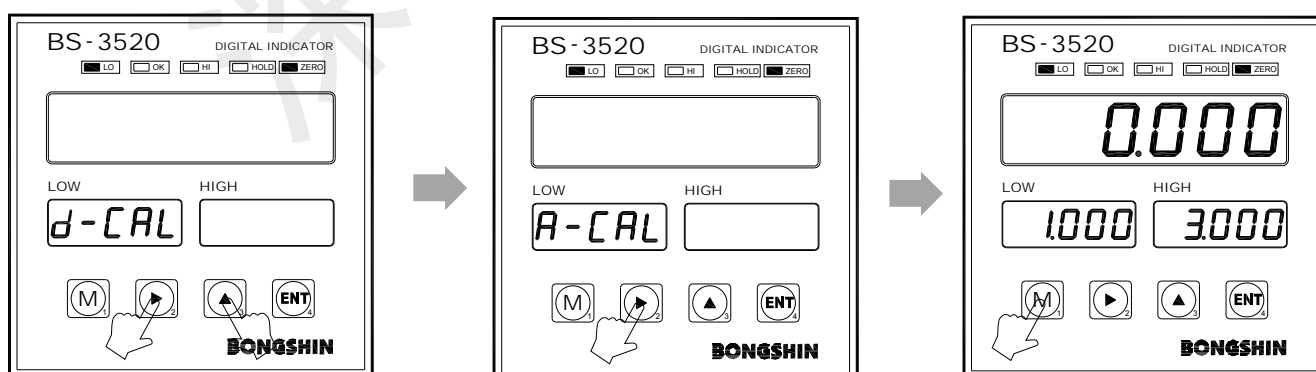

1 It is displayed as figure when pushing no.3 key while pushing no.2 key.

2 Change the mode with No.2 or No.3 key.
(d-CAL→A-CAL→L-CAL)

3 Push No.1 key for mode cancellation.

6-2 Digital calibration mode *d-CAL*

6-2-1 Calibration Method

Step 1. Decimal point setting and min. gradation setting

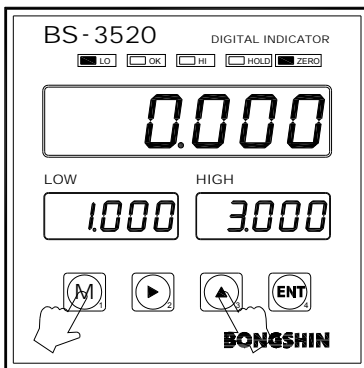

1 When you push No.3 key while pushing No.1 key, entry to function mode is available.

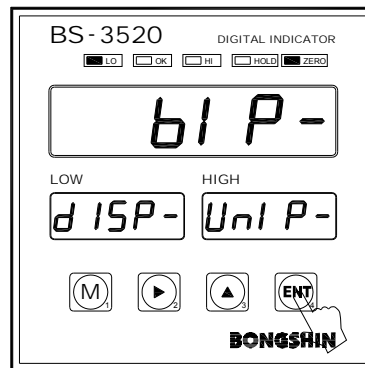

2 It is changed to decimal point mode when you push No. 4 key.

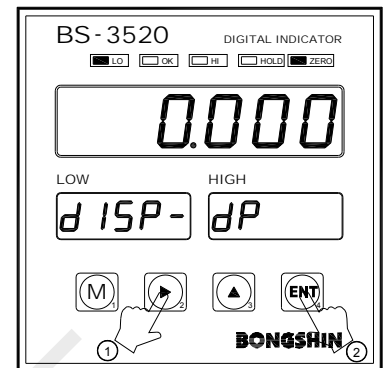

3 Push No.4 key by changing decimal point by pushing No.2 or No.3 key.

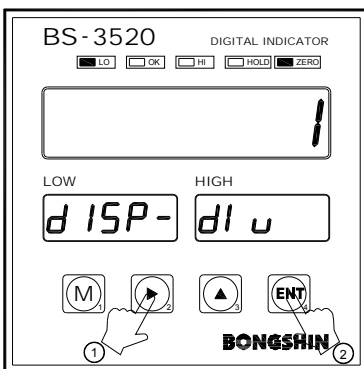

4 Input is completed when you push No.4 key after changing Min, unit with the use of either No.2 or No.3 key.

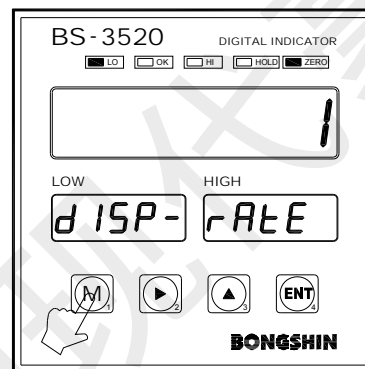

5 It is changed in measurement mode when you push No. 1 Key.

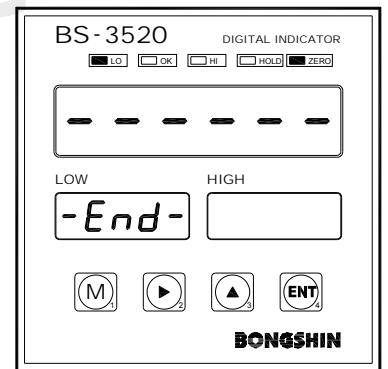

6 Decimal point change and minimum unit change have been completed.

Step 2. Rated output and capacity setting of Load Cell

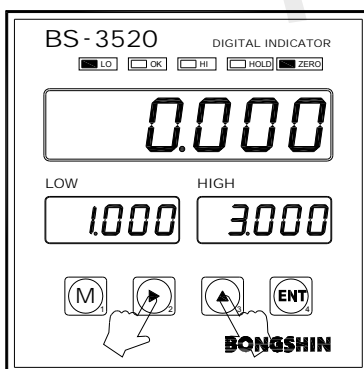

1 Push No.3 key while pushing No.2 key.

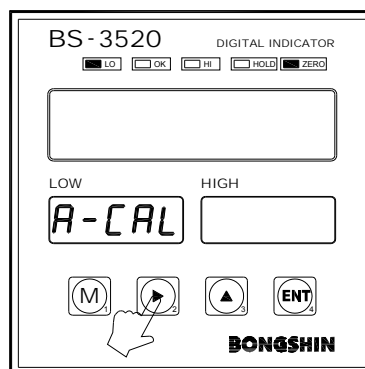

2 Change the mode to *d-CAL* with either No.2 or No.3 key.

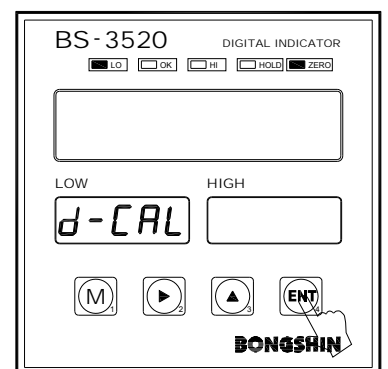

3 Enter into *d-CAL* mode by pushing No.4 key

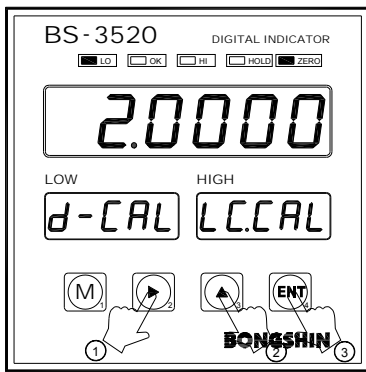

4 Input load cell rated output using No. 2 and No.3 key and Push No.4 key.
(Ex: 2.0000 mV/V)

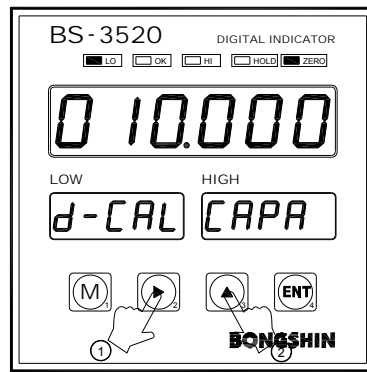

5 Input rated capacity of load cell with the use of No.2 and No,.3 key.
(ex: 15.000 kg)

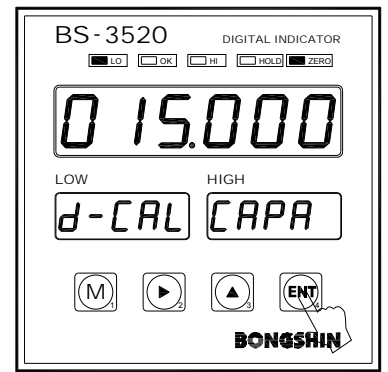

6 Digital input is completed when pushing No.4 key and it returns to measurement mode.

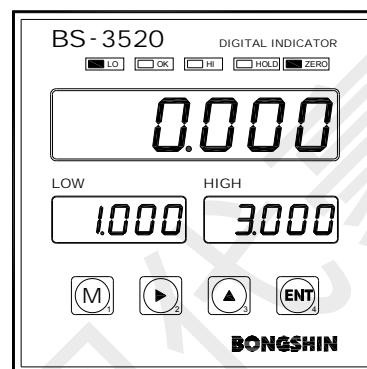
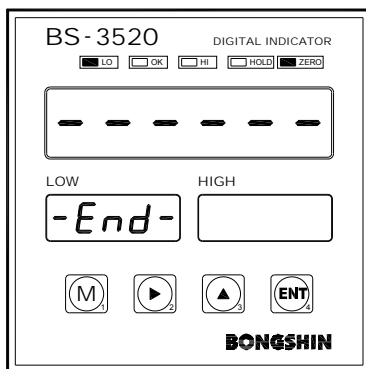

Step 3. Zero Calibration

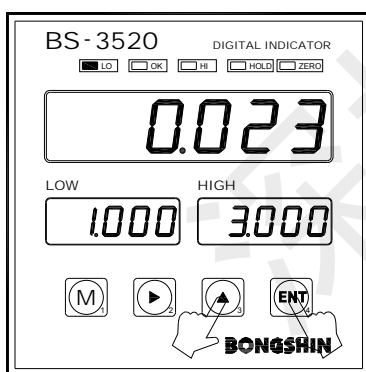

1 Push No.3 key while pushing No.4 key.

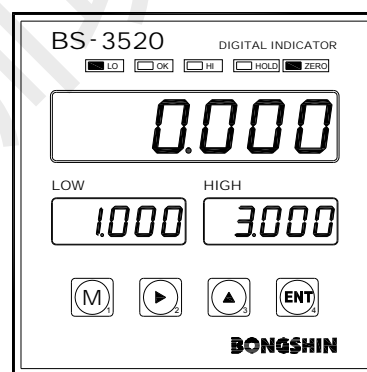

2 Zero calibration is completed.



Warning

- Although the setting range of resolution is 1/20000 or lower but display is conducted even when it exceeds 20000.
- Error may generate for digital calibration mode.
- Conduct regular check on measurement and conduct calibration upon necessity.
- Calibration under instable environment may cause the measurement error.

6-3 Actual load calibration mode *A-CAL*

6-3-1 Calibration Method

Step 1. Decimal point setting and min. gradation setting

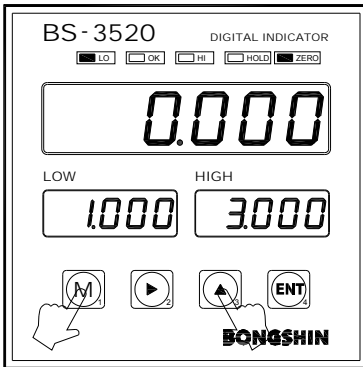

1 Entry to function mode is available when pushing No.3 key while pushing No.1 key.

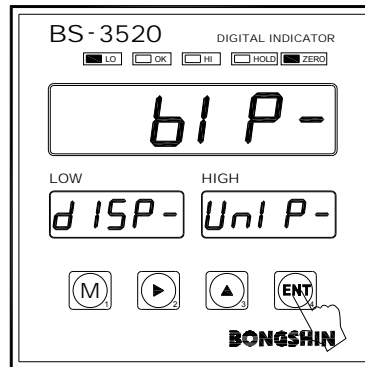

2 It changes to decimal point mode when pushing No.4 key.

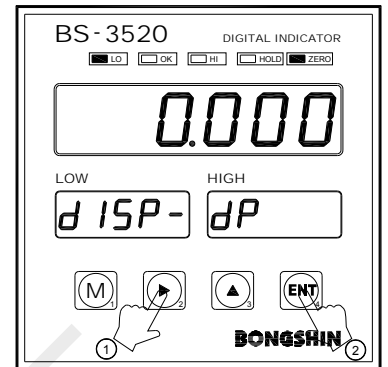

3 Push No. 4 key after changing decimal point by pushing either No.2 or No.3 key.

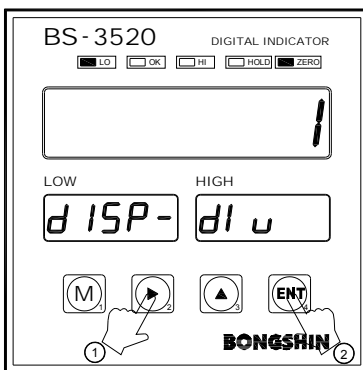

4 Input is completed when you No.4 key after changing min unit by pushing either No.2 or No.3 key.

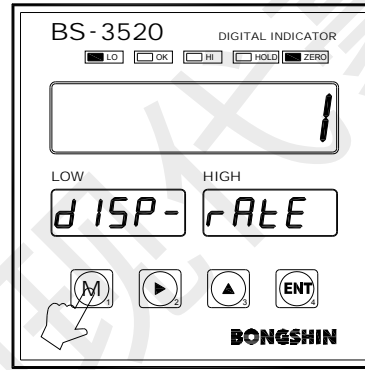

5 It returns to measurement mode when pushing No. 1 key.

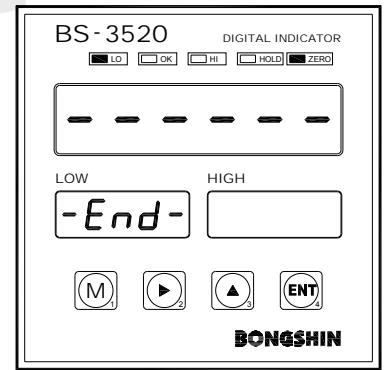

6 Decimal point change and min. unit change have been completed.

Step 2. Zero calibration and dead weight setting

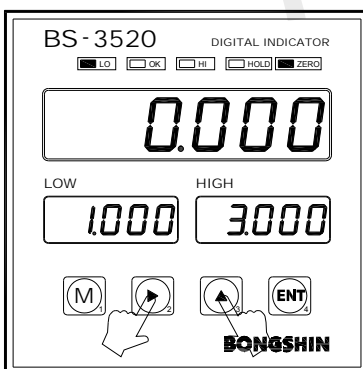

1 Push No.3 key while pushing No. 2 key.

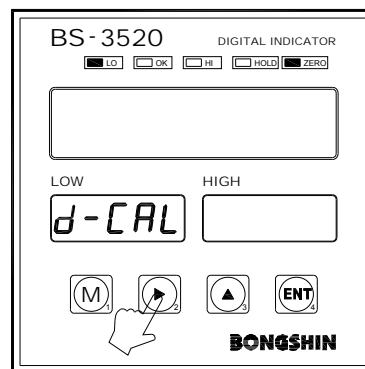

2 Change the mode to *A-CAL* with either No.2 or No.3 key.

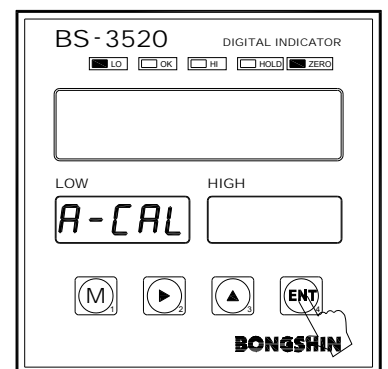

3 Enter into *A-CAL* mode by pushing No.4 key.

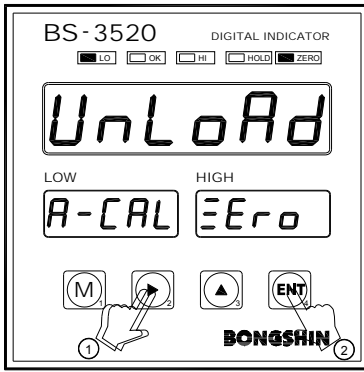

4 Select Unload among Load and Unload with the use of No.2 and No.3 key and push No.4 key when there is nothing on load cell.

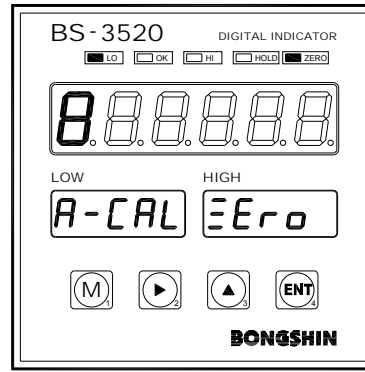

5 Conduct zero calibration.

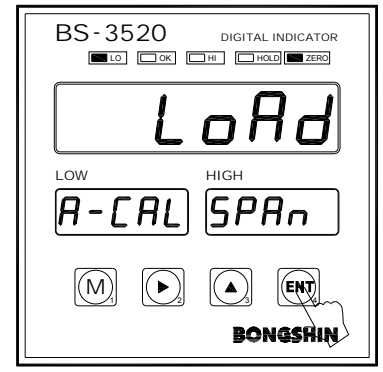

6 It is changed to dead weight value mode when pushing No. 4 key after load display.

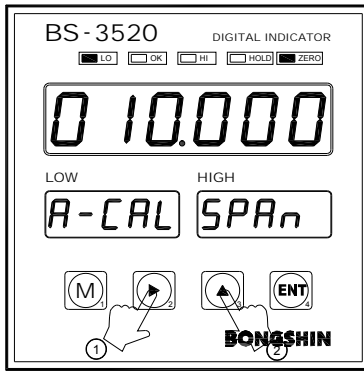

7 Input dead weight value with the use of No. 2 and No.,3 key. Ex) 5.000kg

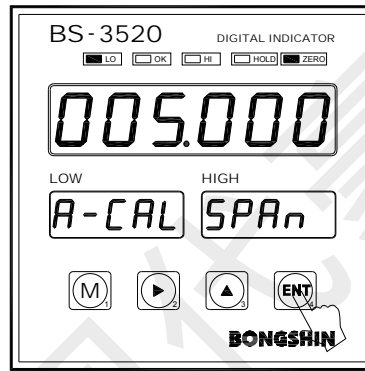

8 Push No.4 key after exerting actual load to load cell.

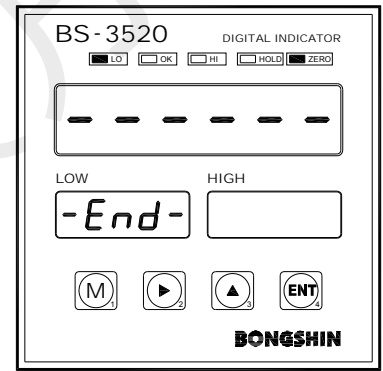

9 Actual load calibration has been completed.

ErrO is played and it is turned to LoAd status when load is small or direction of load is applied toward (-) direction.

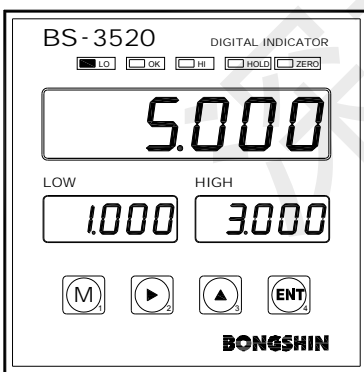

10

Check the dead weight value indicated to display. Check the zero point return status after lowering the dead weight and Step2 shall be executed repeatedly when there is abnormality.



Warning

- Display speed shall be set as slow as possible in function mode during calibration in order to display stable value.
- Although resolution setting range is 1/20000 or lower, display is still conducted when it exceeds 20000.
- Conduct regular check on measurement and conduct calibration upon necessity.
- Calibration under instable environment may cause the measurement error.
- It is recommended that the use of dead weight with over 2/3 of max capacity is recommended in order to reduce the error.

6-4 Linearization Calibration Mode **L-CAL**

6-4-1 Calibration Method

A little measurement error may occur in between the max capacity due to trait of measurement unit even upon the completion of zero and span calibration. Linearization calibration mode is a type of calibration mode which conducts non-linear calibration that reduces the measurement error by conducting calibration with max 4 points excluding the zero with the use of actual load.

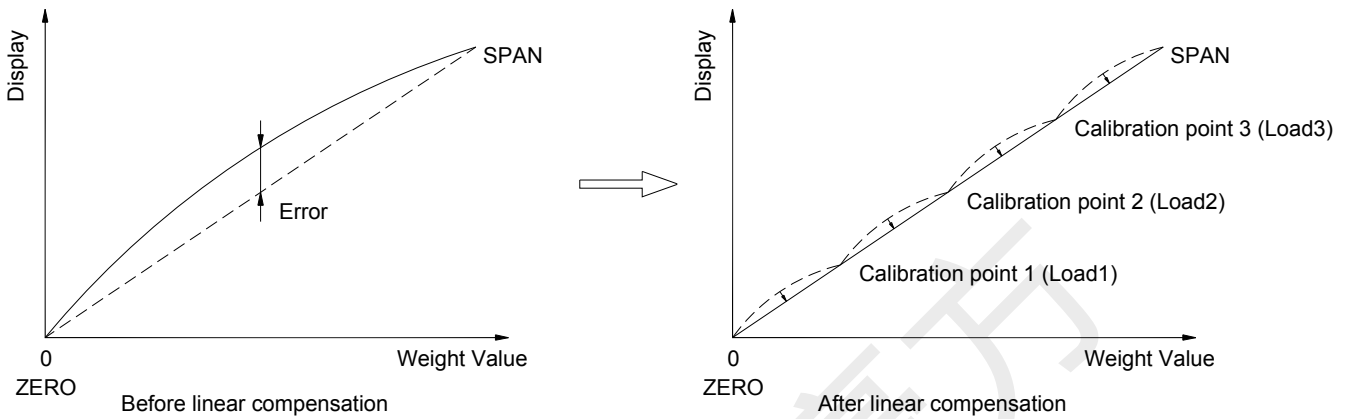

Step 1. Decimal point setting and min gradation setting

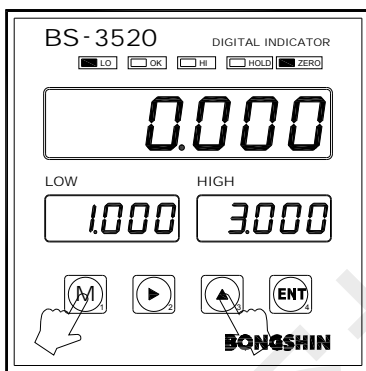

1 Enter into function mode by pushing No.3 key while pushing No.1 key.

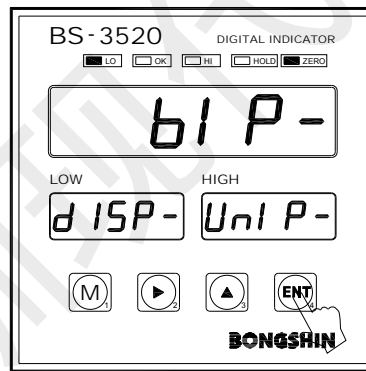

2 It is changed to decimal point mode when pushing No. 4 key.

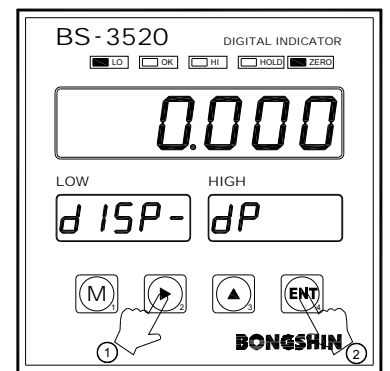

3 Push No.4 key after changing decimal point by pushing either No.2 or No.3 key.

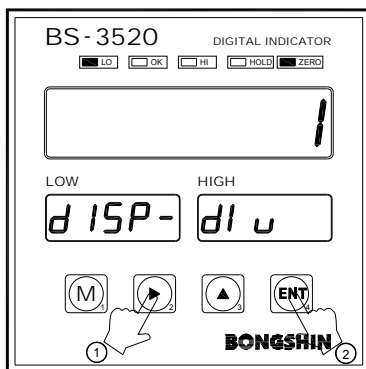

4 Input is completed when you push No.4 key after changing min unit by pushing either No.2 or No.3 key.

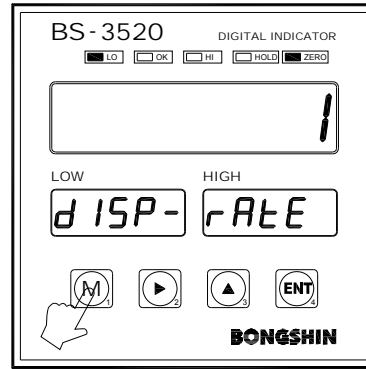

5 It is changed to measurement mode when pushing No.1 key..

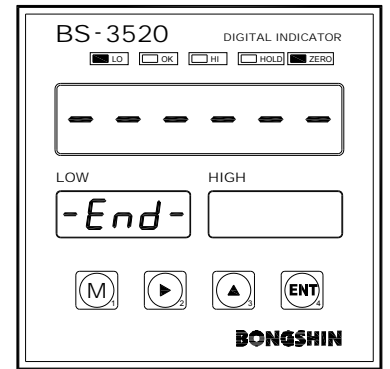

6 Decimal point setting and min. unit setting have been completed.

Step 2. Zero calibration and dead weight setting

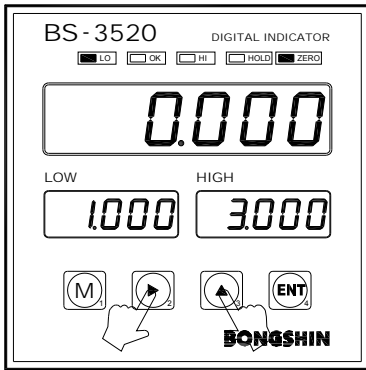

1 Push No.2 key while pushing No.3 key .

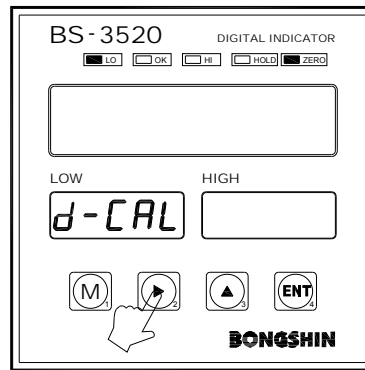

2 It is changed into **L-CAL** mode when pushing either No.2 or No.3 key.

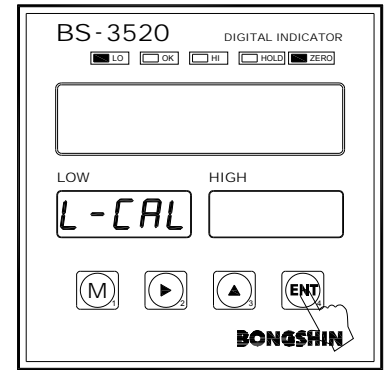

3 Enter into **L-CAL** mode by pushing No.4 key.

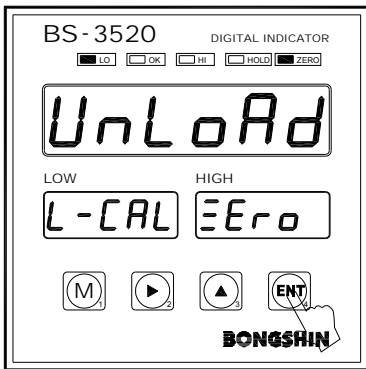

4 Check the stability after display of UnLoad and push No.4 key when there is nothing on load cell.

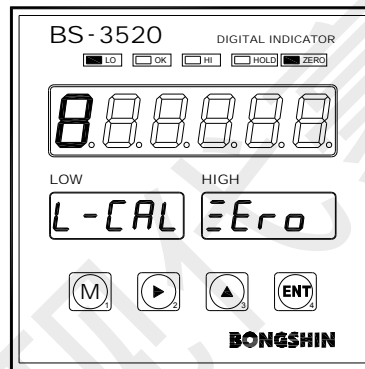

5 Conduct zero calibration.

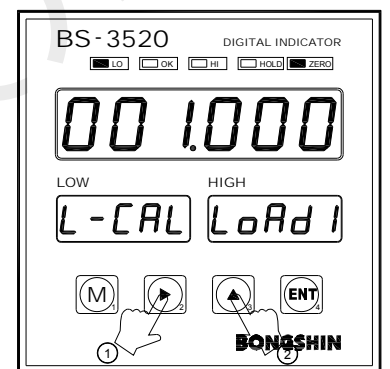

6 Input dead weight value by using No.2 and No.3 key after entering 1st dead weight to measurement unit with display of Load 1.

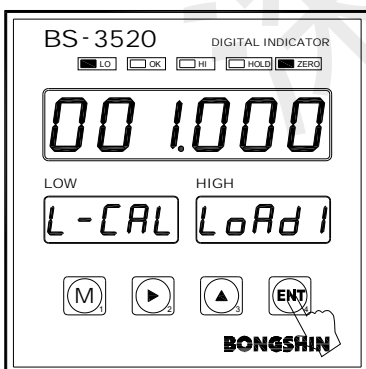

7 1st dead weight value is stored when you push No.4 key after checking the stability.

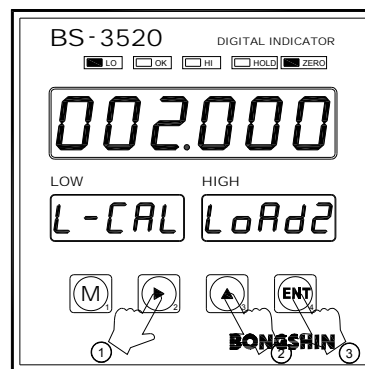

8 Push No.4 key after entering the dead weight value with use of No.2 and No.3 key and entering 2nd dead weight upon display of Load2.

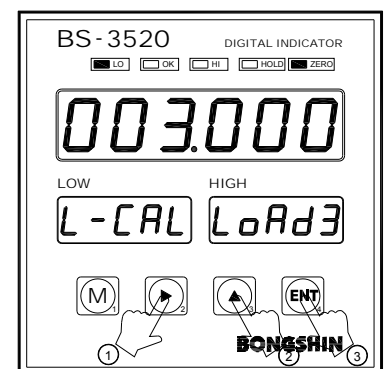

9 Push No.4 key after entering the dead weight value with the use of No.2 and No.3 key and entering 3rd dead weight upon display of Load3.

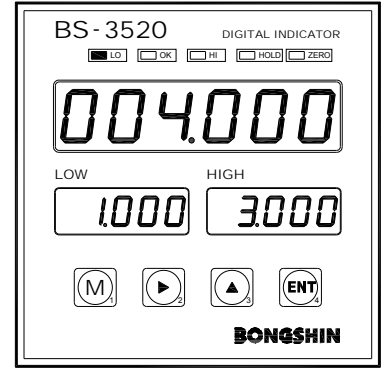
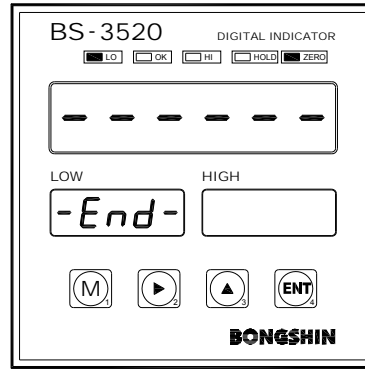
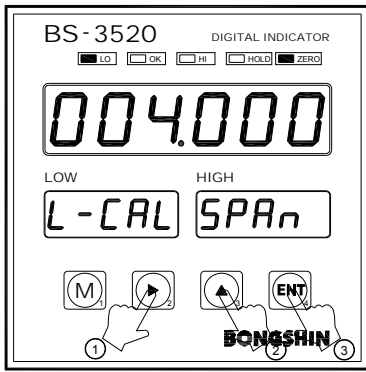

10

Push No.4 key after entering dead weight value with the use of No.2 and No.3 key and entering the last dead weight upon the display of SPAN.

11

Linearization calibration has been completed.

12

Check the dead weight value that is presented at display.



Warning

- Stable value is displayed when the display speed is set as slow as possible from calibration function mode
- Although this function is repetitive, it is not to improve hysteresis.
- Although the setting range of resolution is 1/20000 or lower, display is conducted even when it exceeds 20000.
- Check whether or not regular measurement is conducted and carry out calibration upon the necessity.
- Calibration under instable environment may cause the measurement error.
- Load 1 + Load 2 shall be input for Load 2 dead weight input value, Load 1 + Load 2 + Load 3 for Load 3 dead weight input value is, and Load 1 + Load 2 + Load 3 + SPAN for SPAN dead weight input value.
- In regards to load in use, it shall be Load 1 < Load 2 < Load 3.
When the weight exerted in each stage is small, Err o shall be displayed.
- When there is a mechanical error, the value of linearization differs from input load point upon completion of span calibration thus the difference with measured value may be increased.
- You can exit the measurement mode when you only conduct Load 1 (Load 1~Load 2) and push No.1 key (M).
- In order to reduce the error of dead weight in use, it is recommended that those with remaining capacity of 2/3 or higher shall be used.
- It shall be used after setting Key Lock as illustrated below upon the completion of calibration.

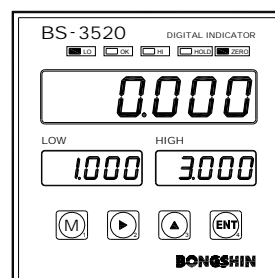
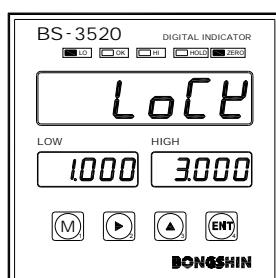
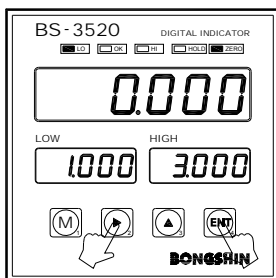

1

Push No.2 while pushing No.4 key.

2

LoCK is displayed and it is changed into key lock mode.

6-5 Digital Zero Calibration

6-5-1 Digital Zero Calibration Method

It shall be executed when there is nothing on the load cell.

Range of zero calibration is 100% of max capacity. It is remembered even when the power is turned off.

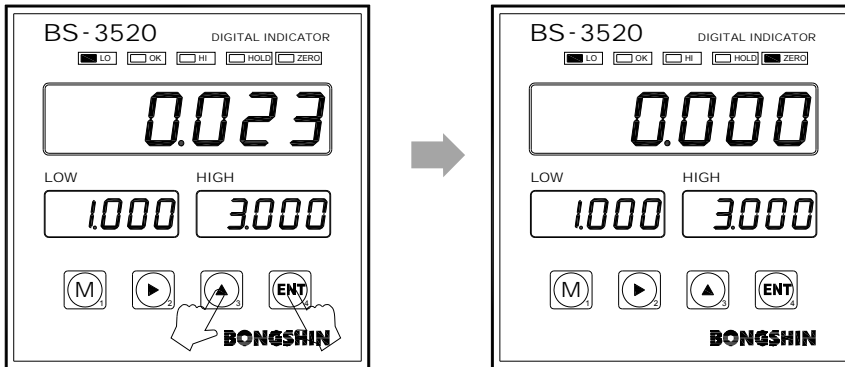

1 Push No.3 key while pushing No.4 key.

2 Zero calibration is completed.



- Zero calibration cannot be conducted under Key Lock status thus it shall be executed after cancelling the Key Lock.
- **Zero calibration is not conducted on the hold.**
- When offset value is set at function, the value other than offset value shall be executed as zero.
- Setting shall be conducted at function in order execute initial zero when turning on the power.
- Zero calibration may not be conducted when there is mechanical interference or load cell abnormality.

6-5-2 Zero Calibration Method by External Input

It shall be executed when nothing is on the load cell.

Relay contact point or contactless switch such as switch or open collector shall be used.

Signal shall be cut off after continuous external input of 10ms or longer.

Please take caution as zero is continuously executed when signal is continuously input not as a pulse.

Range of zero calibration is 100% max capacity. It is remembered even when power is turned off.

Terminal No.	Name	Contents
6	ZERO	Control terminal of zero function Valid at COM1 terminal or terminal block (or on coin)
8	COM1	Common terminal of external control

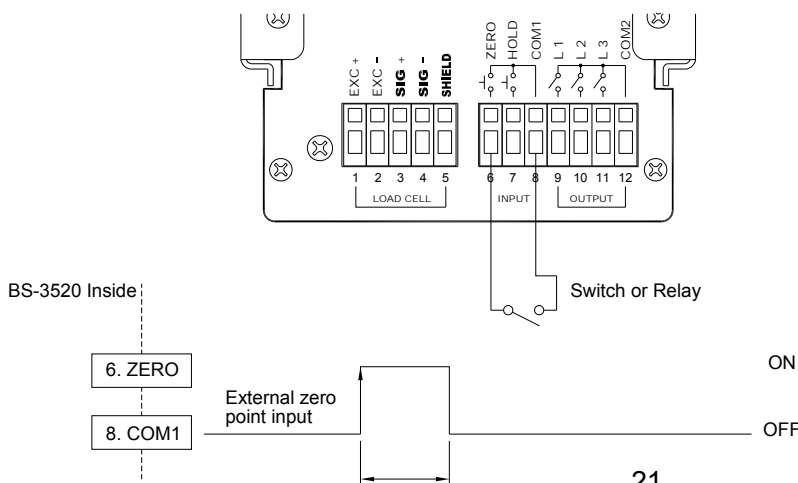

6-5-3 Zero Tracking

Automatic update of zero point shall be conducted by detecting the movement of zero point with the use of zero tracking function (setting shall be conducted at function).

Zero tracking shall only be conducted when width and time function of zero tracking are already set.

Zero tracking is not conducted when zero point is within zero calibration range.

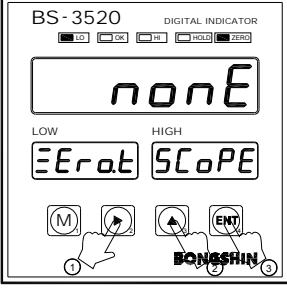
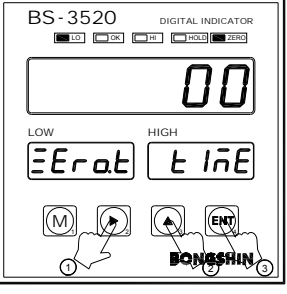
Zero Calibration			
<p>Width of Zero Tracking</p> 	<p>● nonE</p> <p>0.000</p>	<p>None</p> <p>Setting Range 0 ~ 999</p>	<p>Width of zero tracking shall be set.</p>
<p>Time of Zero Tracking</p> 	<p>00</p>	<p>Setting Range 0 ~ 99</p>	<p>Zero tracking operation time shall be set. 00: Operation within 0,1 sec. 01: 0.1 sec ~ 99: 9.9 sec</p> <p>Warning: When 'None' is selected at zero tracking width setting, zero tracking time setting mode shall not be displayed.</p>

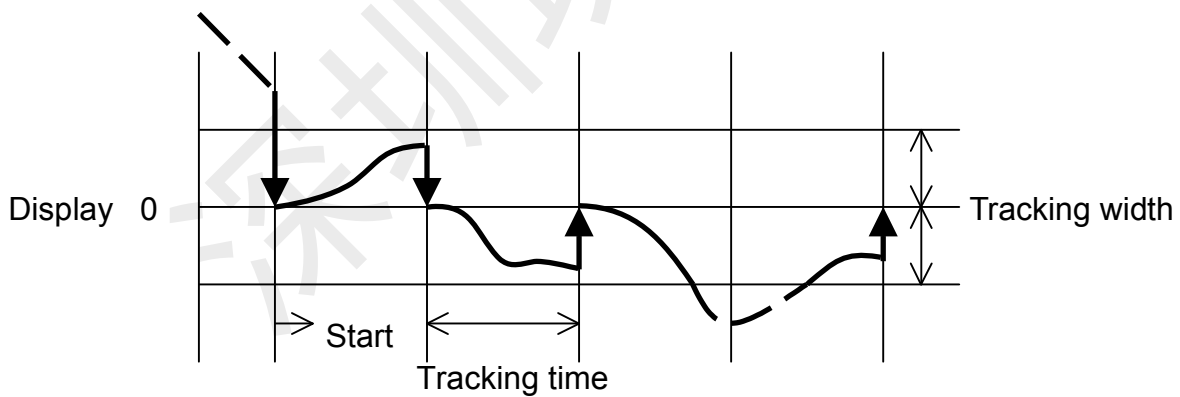

- Zero calibration cannot be conducted under Key Lock status thus it shall be executed after cancelling Key Lock status.
- Zero tracking is not operated when offset value is set at function.
- When there is a dramatic change in load by vibration even within the range of zero tracking width, zero tracking setting times is doubled thus there may be a delay in conduct of automatic zero calibration.

6-5-4 Power On Zero

Digital zero shall be conducted when the power is turned on.

(setting shall be conducted at function).

Zero calibration shall be conducted based on power input point.

Take caution in use when there are contents such as hopper scale and others.

Range of zero calibration is 100% of max capacity. It is remembered even when the power is turned on.

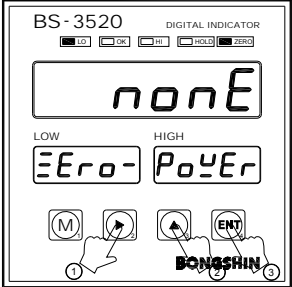
Item Display	Setting Value	Setting Contents	
<p>Automatic Zero Point Mode</p> 	<ul style="list-style-type: none"> ● nonE AUto 	<p>None</p> <p>Automatic Zero Point</p>	<p>It is a function to automatically execute the zero calibration with power input (upon Power On).</p>









- It cannot be returned when it is turned into zero point after automatic execution of zero point.
 - When offset value is set at function, automatic zero point is executed excluding the value that has already been set.
- For instance, -1000 is displayed when offset value is set as 1000 and power is turned off and on again with the display of current value of 5230.

7. Function Mode

It is description on function mode which sets various functions.

7-1 Function Setting Method

7-1-1 Mode Entry Method

1. It turns into the mode selection status when  key is pushed while pushing  key is pushed at measurement status.
2. Mode change and setting value change is available when  key or  key is pushed at mode selection status.
3. Push  key in order to move onto next stage after saving the setting value at mode selection status.
4. Push  key to cancel the setting and return to measurement mode for mode cancellation.
At the mode cancelation, the setting until previous stage of cancellation is saved.

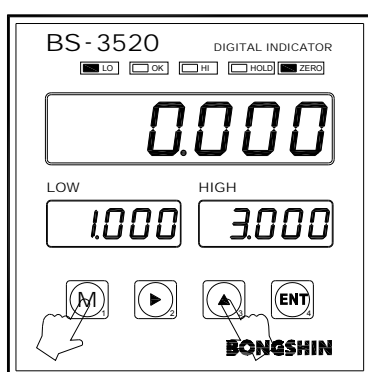

1 It is entered into function mode when pushing No.3 key while pushing No.1 key.

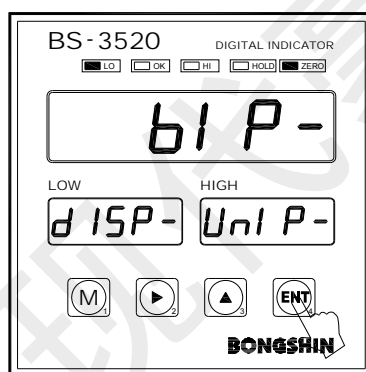

2 It proceeds to next stage when pushing No.4 key.

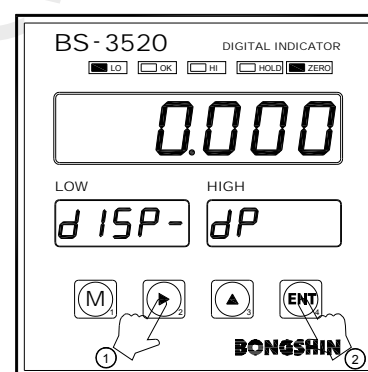

3 It is saved when pushing No.4 key after changing setting value by pushing No.2 or No.3 key.

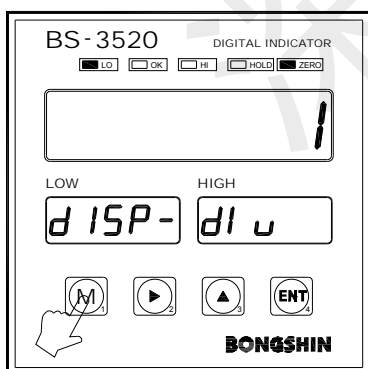

4 It proceeds to next stage when pushing No.4 key and is changed into measurement mode when pushing No.1 key.

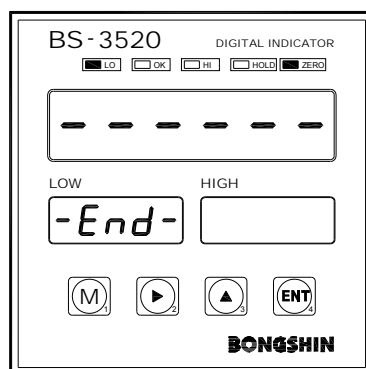

5 Function setting has been completed and setting value is saved.

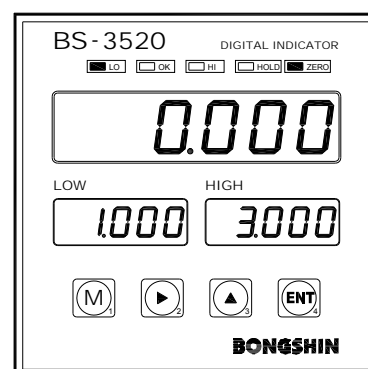

6 It is changed into measurement mode status.

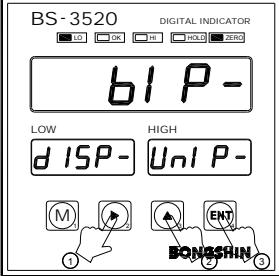
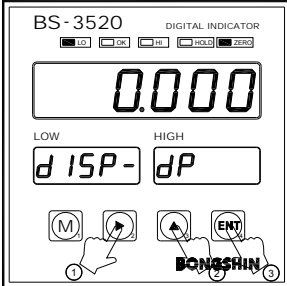
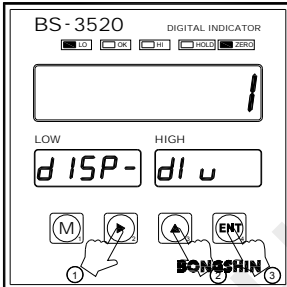
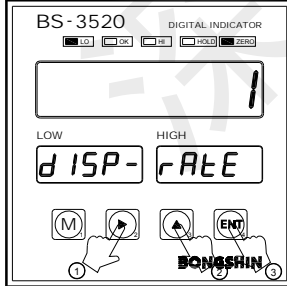
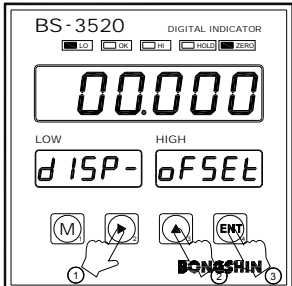

7-2 Function Items

Item Display	Setting Value	Contents of Setting
Display		
Polarity Display 	<ul style="list-style-type: none"> ● bip- : Display of both +/- UnIP : No display of -polarity 	<p>Display (-) value shall be selected.</p> <p>Zero lamp is turned off when load display value goes down under (-) value with zero point as its reference in case of UnIP setting.</p> <p>Although load display is 0, it is actually (-) value status.</p>
Location of Decimal Point 	<ul style="list-style-type: none"> 0 : No 0.0 : 1 digit 0.00 : 2 digit ● 0.000 : 3 digit 0.0000 : 4 digit 	<p>Location of decimal point shall be selected.</p>
Min Gradation 	<ul style="list-style-type: none"> ● 1 : 0,1,2,3,4 ... 2 : 0,2,4,6,8 ... 5 : 0,5,10,15,20... 10 : 0,10,20,30,40... 20 : 0,20,40,60,80... 50 : 0,50,100,150... 	<p>Min gradation shall be set.</p> <p>Warning: Random change is available even after the completion of calibration. However, the calibration shall be conducted again in case of decimal point change (change in number of digits).</p>
Display Conversion Speed 	<ul style="list-style-type: none"> ● 1 : 4.7 times/sec 2 : 7.5 times/sec 2.5 : 10 times/sec 12.5 : 50 times/sec 15 : 60 times/sec 38 : 150 times/sec 75 : 300 times/sec 240 : 960 times/sec 600 : 2400 times/sec 1200 : 4800 times/sec 	<p>Slow</p> <p style="text-align: center;">↑</p> <p style="text-align: center;">It is display conversion speed of measurement value.</p> <p style="text-align: center;">↓</p> <p>Fast</p>
Container Value Setting (OFFSET) 	<ul style="list-style-type: none"> ● 00.000 : Setting Range -99999 ~ 99999 	<p>Container weight value is set. Setting of (-) value or (+) value shall be displayed.</p> <p>For instance, in case of 01.000 setting, -1.000 is displayed when you exit function mode. (no display under UnIP setting)</p> <p>Warning: Setting of (-) and (+) value shall be maintained even when zero point calibration is conducted. In order to display 0 at measurement mode, All of set container value shall be 0.</p>

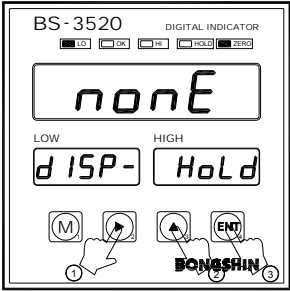
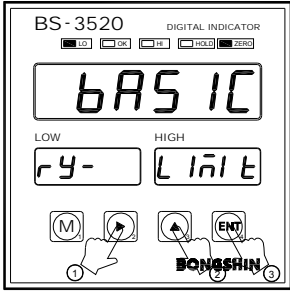
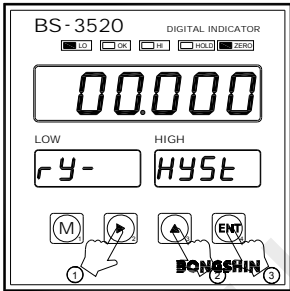
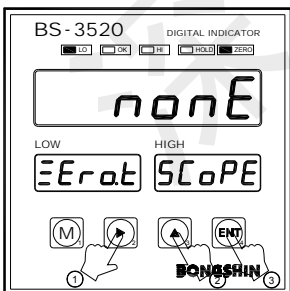
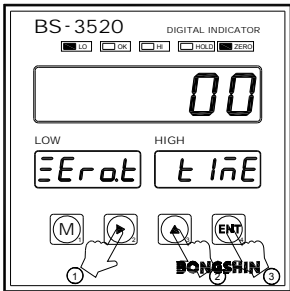

● : Initial Value

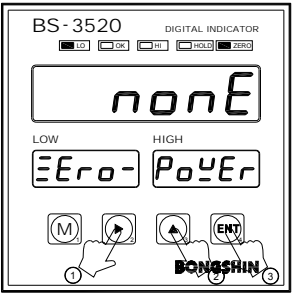
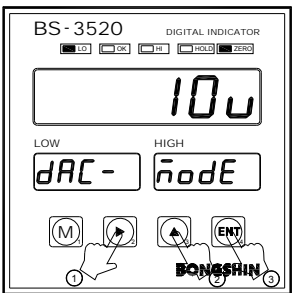
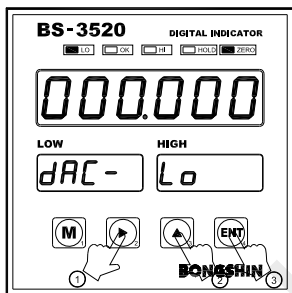
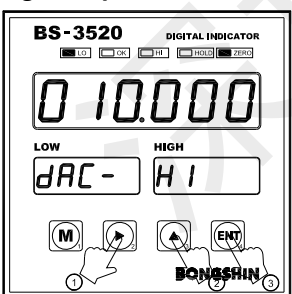
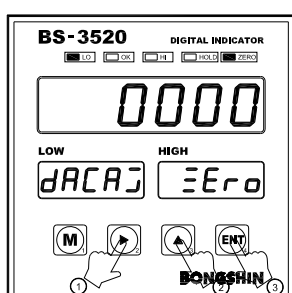
Item Display	Setting Value	Contents of Setting
<p>Hold Mode</p> 	<ul style="list-style-type: none"> ● NonE : None EdGE : Edge Hold PK : PK Hold 	<p>Select the hold function.</p> <p>Warning : In case it is set as 'None', it does not operate even when signal is given from key hold and external contact point.</p>
Relay		
<p>Relay Mode</p> 	<ul style="list-style-type: none"> ● bASIC : Basic limit mode HY_HI : High limit mode HY_Lo : Low limit mode HY_LLH : Low Low High limit mode NonE : None 	<p>Select relay mode.</p> <p>Warning: In case it is set as 'None', nothing is displayed to low, and high display unit.</p>
<p>Hysteresis Width</p> 	<ul style="list-style-type: none"> ● 00.000 : Setting Range 0 ~ 999 	<p>Width of hysteresis shall be set.</p>
Zero Calibration		
<p>Zero Tracking Width</p> 	<ul style="list-style-type: none"> ● nonE : None 0.000 : Setting Range 0 ~ 999 	<p>Zero tracking width shall be set.</p>
<p>Zero Tracking Time</p> 	<ul style="list-style-type: none"> 00 : Setting Range 0 ~ 99 	<p>Zero tracking time shall be set.</p> <p>00: Operation within 0.1 sec 0 : 0.1 sec ~ 99 : 9.9 sec</p> <p>Warning : When it is selected as 'None' at zero tracking width setting, zero tracking time setting mode is not displayed.</p>

● : Initial Value

Item Display	Setting Value	Contents of Setting
<p>Automatic Zero Point Mode</p> 	<ul style="list-style-type: none"> ● nonE : None Auto : Automatic Zero Point 	<p>It is a function to execute automatic zero upon power input (Power On).</p>
Analog Output (DAC)		
<p>Analog Output Mode</p> 	<ul style="list-style-type: none"> ● 10V : 0 ~ 10V output ±5V : -5V ~ +5V output ±10V : -10V ~ +10V output 4~20mA : 4 ~ 20mA output 0~20mA : 0 ~ 20mA output 5V : 0 ~ 5V output 	<p>Analog output mode shall be selected.</p> <p>Warning: Analog output minute calibration shall be conducted again in case of changing output mode.</p>
<p>Analog Lo Output</p> 	<ul style="list-style-type: none"> ● 000.000 Setting Range -199999 ~ 999999 	<p>In case analog output is 0V/ 0mA/ 4mA, display value shall be set.</p> <p>Analog output is conducted by force while digit is flickering. (in case only one digit is flickering)</p>
<p>Analog High Output</p> 	<ul style="list-style-type: none"> ● 010.000 : Setting Range -199999 ~ 999999 	<p>In case analog output is 5V/ 10V/ 20mA, display value shall be set.</p> <p>Analog output is conducted by force while digit is flickering (in case only one digit is flickering)</p>
<p>Analog Lo Output Minute Calibration</p> 	<ul style="list-style-type: none"> ● 0000 : Setting Range -9999 ~ 9999 	<p>In case it is 0V/ 0mA/4mA, minute calibration of analog output shall be conducted with the change in setting value.</p> <p>Value is increase by 10 while pushing  key.</p> <p>It decreased by 10 while pushing  Key.</p>

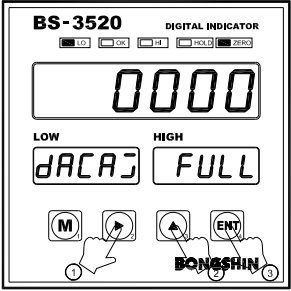
● : Initial Value

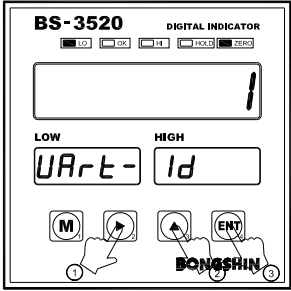
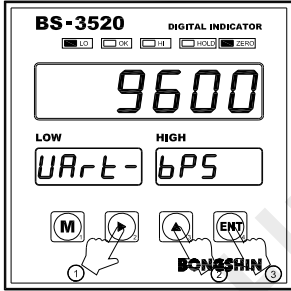
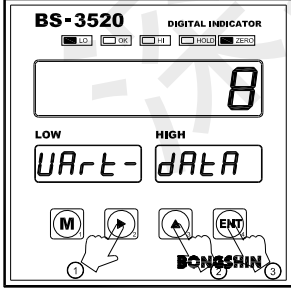
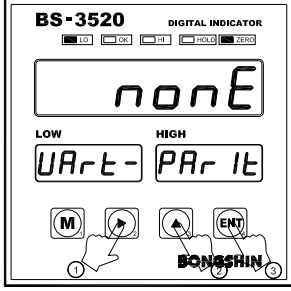
Item Display	Setting Value	Contents of Setting
<p>Analog Full Output Minute Calibration</p> 	<ul style="list-style-type: none"> ● 0000 : 	<p>Setting Value -9999 ~ 9999</p> <p>In case it is 0V/ 0mA/4mA, minute calibration of analog output shall be conducted with the change in setting value. Value is increase by 10 while pushing  key. It decreased by 10 while pushing  Key.</p>
Communication Output		
<p>Communication ID</p> 	<ul style="list-style-type: none"> ● 1 : 	<p>Setting Range 00 ~ 99</p> <p>Communication address shall be selected.</p>
<p>Communication Speed</p> 	<ul style="list-style-type: none"> ● 1200 : 2400 : 4800 : 9600 : 19200 : 38400 : 57600 : 115200 : 	<p>1200 bps 2400 bps 4800 bps 9600 bps 19200 bps 38400 bps 57600 bps 115200 bps</p> <p>Communication transmission speed shall be set.</p>
<p>Data Length</p> 	<ul style="list-style-type: none"> ● 7 : ● 8 : 	<p>7 bits 8 bits</p> <p>Communication data length shall be set.</p> <p>Warning : For 7bits setting, the parity bit shall be set as either even or odd. When it is set as none, communication data may be broken.</p>
<p>Parity Bit</p> 	<ul style="list-style-type: none"> ● nonE : Odd : EvEn : 	<p>None Odd Even</p> <p>Communication parity shall be set.</p>

● : Initial Value

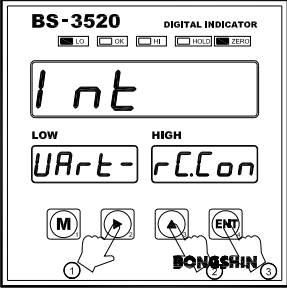
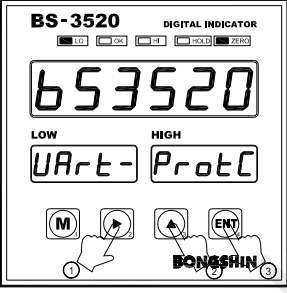
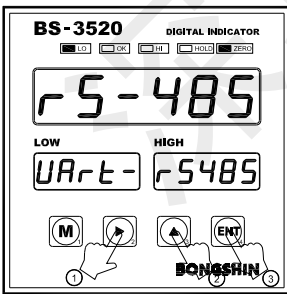
Item Display	Setting Value	Contents of Setting
<p>Number of Communication Output</p> 	<ul style="list-style-type: none"> ● Int : 0.10 	<p>Stream mode setting range 0.01 ~ 9.99</p> <p>Number of communication output shall be set.</p> <p>0.01: 0.01 sec/time ~ 9.99: 9.99 sec/time</p> <p>Data is transmitted for each set time interval.</p> <p>Warning : Transmission is not conducted with the setting of 0.00 and there may be an overlapping of transmission packet when communication speed is set to be slow in high speed transmission. In case of setting transmission speed is conducted as 9600bps or lower, it shall be set as 0.1 sec or longer.</p>
<p>Communication format</p> 	<ul style="list-style-type: none"> ● bS3520 : BONG SHIN Format And : AND Format 	<p>Select communication format.</p> <p>Warning : In case of AND Format setting, command mode is same as the 12-2-2 command mode.</p>
<p>Communication RS-422/485 setting</p> 	<ul style="list-style-type: none"> r S-422 : RS-422 ● r S-485 : RS-485 	<p>Select RS-422/485 communication.</p> <p>Warning : After changing from RS-485 to RS-422, turn the power off and then use is after turning it on. Please use it after checking the output pin no.</p>

● : Initial Value



- Since entry to setting mode is unavailable from Key Lock status, it shall be executed after canceling the key lock.
- There may be a change in display of setting range based on location of decimal point.
- **Item to set DAC is not displayed when selecting BCD option.**
- Function setting value can be initialized at check mode.

8. HOLD

Hold function is a function to stop the display.

Hold and cancellation can be conducted from front key or control terminal.

In order to conduct hold, hold mode shall be selected from the function.

8-1 Hold Mode

8-1-1 Hold Operation

Hold can be operated with the method by hold key, hold input terminal of rear panel, and communication.

When the hold is operated, hold lamp flickers.

First executed operation has the priority in hold operation.

■ Method by hold key

Hold is commenced and hold value is displayed when pushing No.1 key while pushing No.4 key.

When pushing No.1 key while pushing No.4 key again during the hold, hold is cancelled and measurement value is displayed.

■ Method by external hold input terminal

Hold is commenced when external hold input terminal is turned on (contact point input).

At the moment, external hold input terminal shall maintain the on status.

Hold is cancelled when input is conducted at off status.

■ Method by serial output (RS-232C/422/485) command order

Hold is commenced by the hold on command with communication and hold is cancelled by hold off command.

8-1-2 Hold mode selection method

1. It turns into the mode selection status when key is pushed while pushing key is pushed at measurement status.
2. Hold mode selection item comes out when you push key 5 times at mode selection status.
3. Mode change and setting value change is available when key or key is pushed at mode selection status.
4. Push key in order to move onto next stage after selecting the hold mode and saving.
5. Push key to cancel the mode and return to measurement mode.

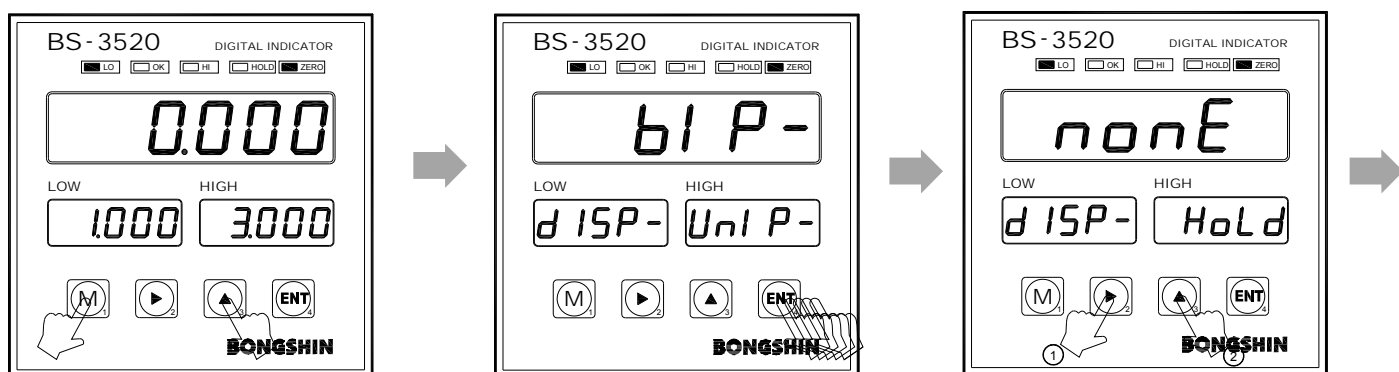

1 It is entered into function mode when pushing No.3 key while pushing No.1 key.

2 Hold mode selection stage is conducted when pushing No.4 key 5 times.

3 Change the hold mode by pushing either No.2 or No.3 key.

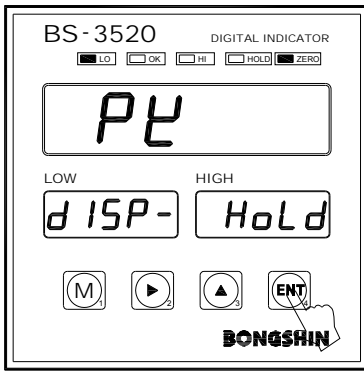

4 It moves onto next stage after saving option item when pushing No.4 key after changing PK hold change.

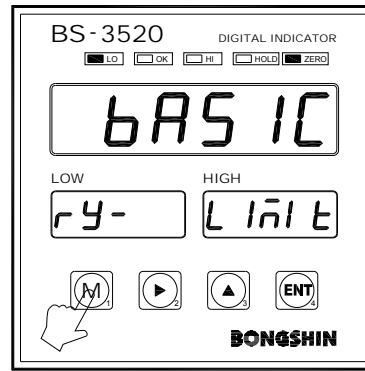

5 It is changed to measurement mode when pushing No.1 key.

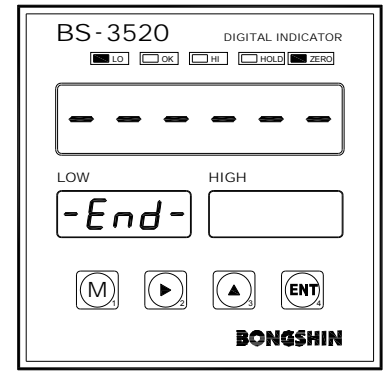

6 Function setting has been completed and setting value shall be saved.

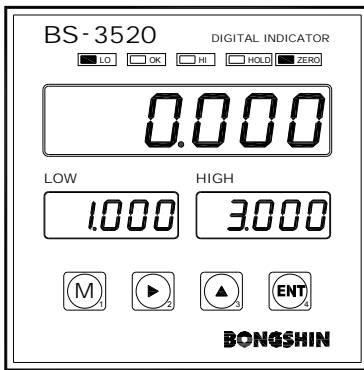

7 It is changed to measurement mode status



- Entry to setting mode is unavailable under key lock status thus it shall be executed after canceling the key lock.
- Setting range display may differ based on location of decimal point.
- In case of setting hold function as 'None', key hold and external contact point hold are not operated.
- In case of PK hold setting, hold is not conducted for (-) display value. (hold of (-) display value is available in case of edge hold)
- Function setting value can be initialized at check mode.

8-2 Hold Type

8-2-1 Edge hold mode

Edge hold conducts hold of display and output at the moment of hold input.

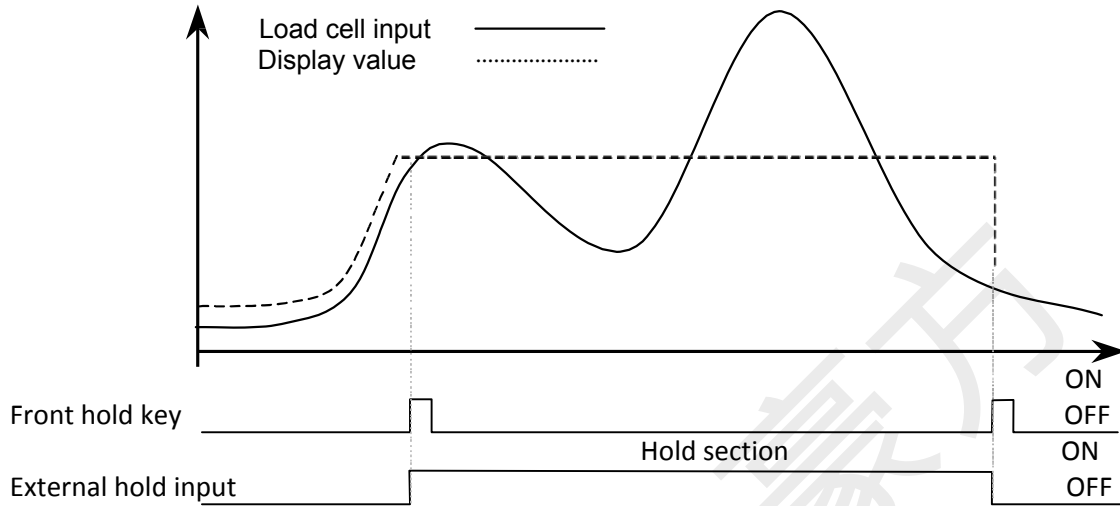

8-2-2 Peak hold mode

PK hold conducts hold of PK display and output at the moment of hold input.

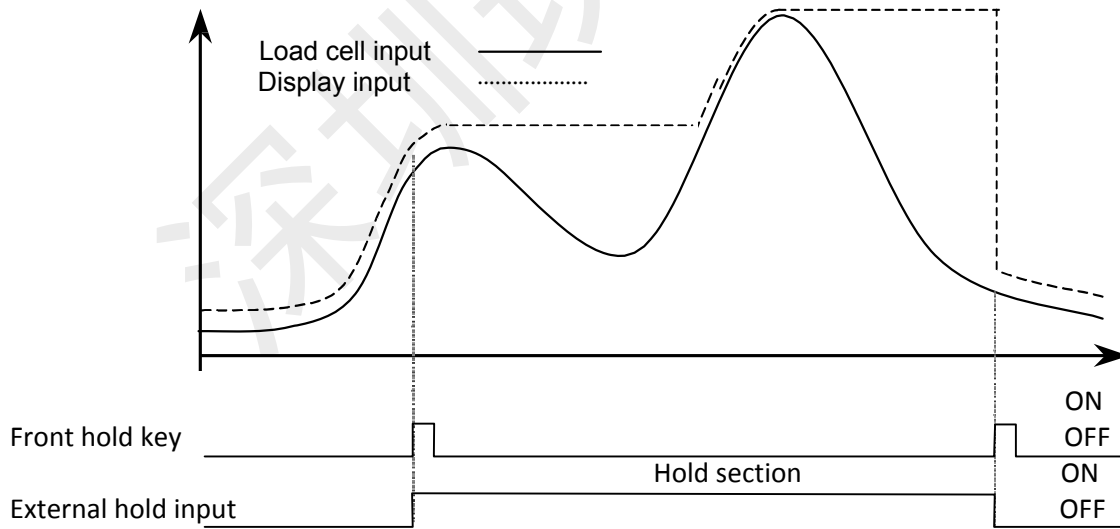

8-3 Hold Operation

8-3-1 Operation by hold key (Hold ON)

Hold is commenced when you push No.1 key while pushing No.4 key and hold value is displayed.

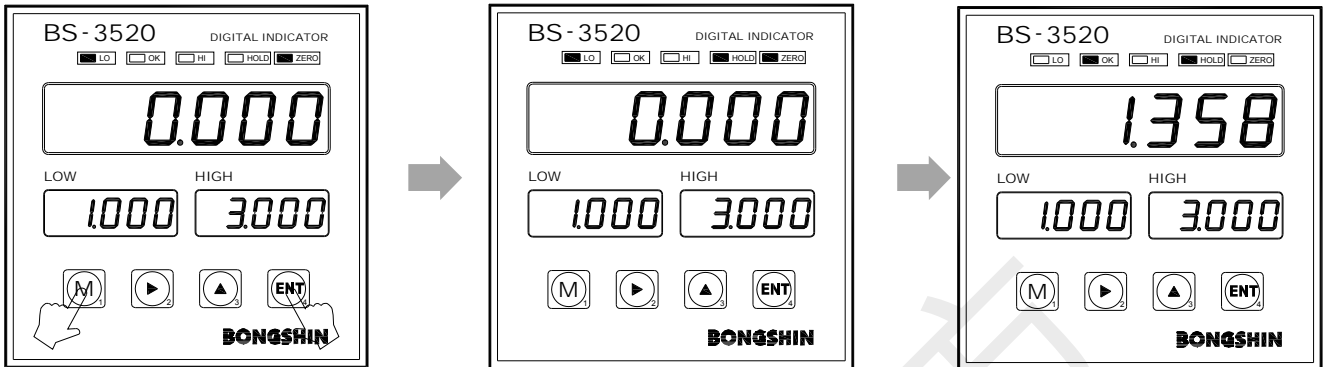

1 Hold is commenced when pushing No.1 key while pushing No.4 key.

2 Hold lamp is flickered and hold is commenced. Load is exerted in case of PK hold.

3 Display is made with PK hold.



- In case of edge hold setting, hold is conducted for display and output at the moment of key hold input.
- In case of PK hold setting, holding of PK display and output is conducted before cancelation of hold.

8-3-2 Operation Cancelation by Hold Key (Hold OFF)

Hold is cancelled when pushing No.1 key while pushing No.4 key.

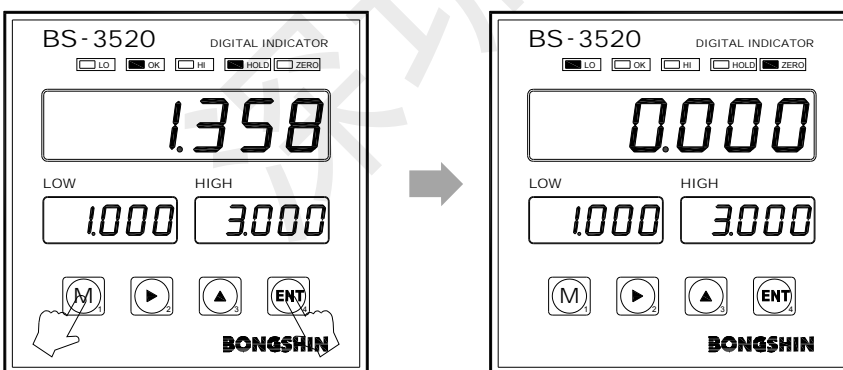

1 Hold is cancelled when pushing No.1 key while pushing No.4 key.

2 Hold lamp is flickered and hold value is cancelled.



- Key hold is not operated under Key Lock status. It shall be executed after canceling the key lock.
- Range setting display may differ based on location of decimal point.
- In case of PK hold setting, holding of (-) display value is not conducted. (hold of (-) display value is available in case of edge hold)

8-3-3 Method by external hold input terminal

Hold is commenced when external hold input terminal is turned on (contact point input).
 At the moment, external hold input terminal shall maintain On status.
 Hold is cancelled when input is conducted under Off status.

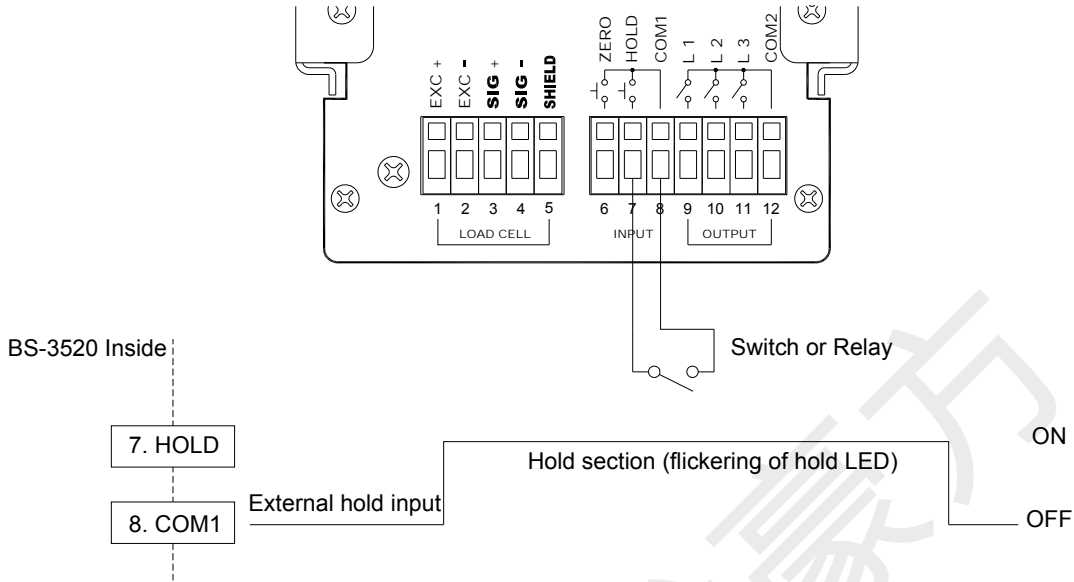



- Operation is not conducted when hold mode is not set as edge or PK hold from function.
- **Switch shall be zero voltage input of machine contact point and semiconductor contact point.**
- **Zero calibration is not conducted under Hold status.**
- ON, OFF time shall be secured for 10ms or longer.
- Please use it within rated load.

8-3-4 Method by serial output (RS-232C/422/485) command

Hold is commenced by hold on command through communication and hold is cancelled by hold off command.
 Please refer to 12. Serial Output for detailed contents.

1. Hold ON command Hold is commenced.

Command Example

		ID		Command	
1	2	3	4	5	
<STX>	0	1	H		<ETX>

2. Hold OFF command Hold is cancelled.

Command example

		ID		Command	
1	2	3	4	5	
<STX>	0	1	C		<ETX>

9. Relay Mode

Relay operation mode shall be selected from function.

Relay output shall be conducted from output terminal L1(LO), L2(OK), and L3(HI) or rear panel.

9-1 Relay Mode

9-1-1 Relay mode selection method

1. It turns into the mode selection status when key is pushed while pushing key is pushed at measurement status.
2. Relay mode selection item comes out when you push key 6 times at mode selection status.
3. Mode change is available when key or key is pushed at mode selection status.
4. Push key in order to move onto next stage after selecting the relay mode and saving.
5. Push key to cancel the mode and return to measurement mode.

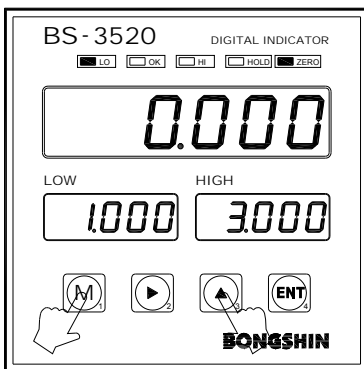

1 It is entered into function mode when pushing No.3 key while pushing No.1 key.

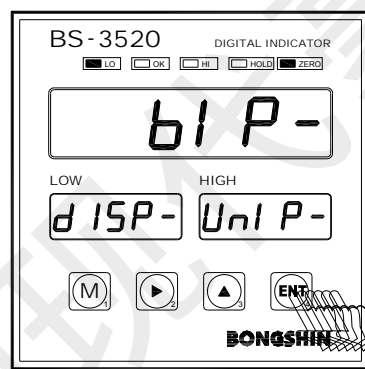

2 It proceeds with relay mode selection stage when pushing No.4 key 6 times.

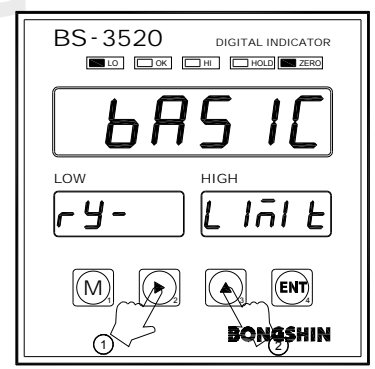

3 Relay mode is changed by pushing either No.2 or No.3 key.

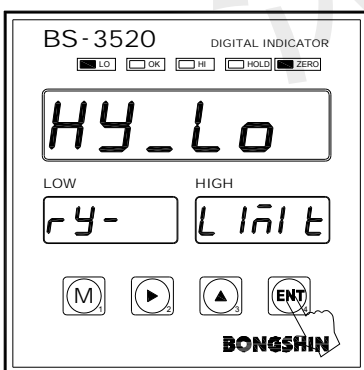

4 It moves onto next stage after saving selected item when pushing No.4 key after the mode change.

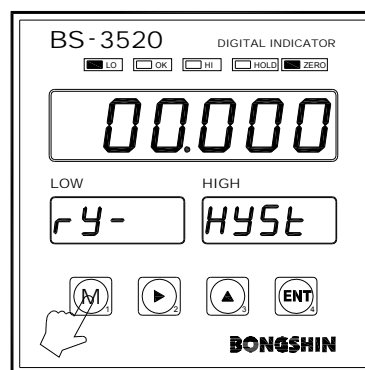

5 It is changed into measurement mode when pushing No.1 key.

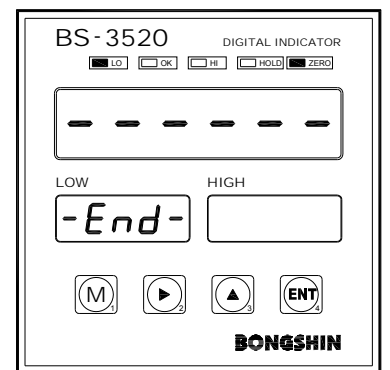

6 Function setting has been completed and it turns into measurement mode status after saving the setting value.

9-1-2 Lo and Hi setting method (Lo, HI setting)

1. It turns into setting available status when you push (M) key while pushing (▲) key at measurement status.
2. Relay setting value change in available with the use of (▶) key or (▲) key.
3. It moves onto next stage when pushing (ENT) key after relay setting value changing and saving.
4. It turns into measurement mode when pushing (M) key in case of mode cancellation.

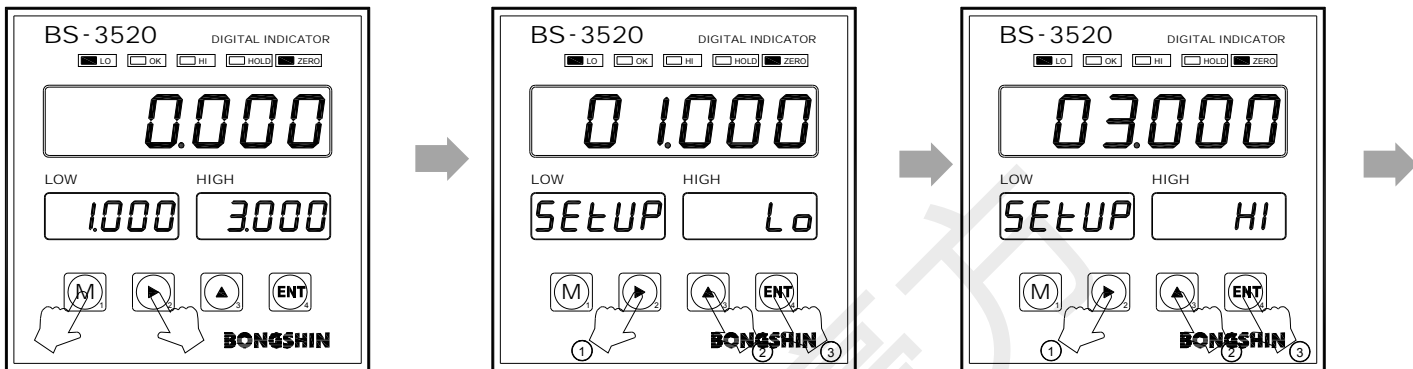

- 1 It is entered into relay setting value change mode when pushing No.2 key while pushing No.1 key.
- 2 When pushing No.4 key after changing Lo relay setting value with the use of No.2 and No.3 key, it moves onto next stage.
ex) 1.000kg
- 3 When pushing No.4 key after changing Hi relay setting value with the use of No.2 and No.3 key, it turns into measurement mode.
ex) 3.000kg

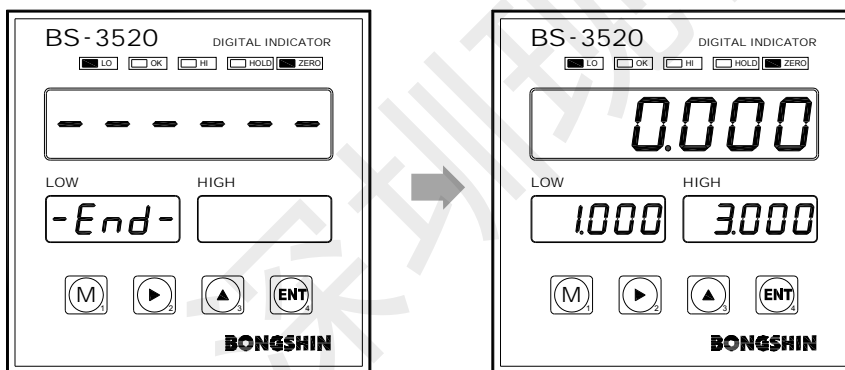







- 4 Relay setting has been completed and setting value is saved.
- 5 It turns into measurement mode status.



- Entry to setting mode is available under Key Lock status.
- Setting range display may differ based on location of decimal point.
- Although meter display unit is 6 digit, Lo and Hi display unit is 5 digit. Therefore, no display is available for setting value of 6 digit. (minus value setting up to -19999 is available)
- Relay setting value can be initialized at check mode.
- You can exit measurement mode when set Lo only and push No.1 key (M).
- OK setting and output are operated within Lo and Hi setting value range. (OK setting is not conducted separately)

9-1-3 RY1(L1), RY2(L2), RY3(L3) relay value setting method

1. It turns into setting available status when you push  key while pushing  key at measurement status.
2. Relay setting value change in available with the use of  key or  key
3. It moves onto next stage when pushing  key after relay setting value changing and saving.
4. It turns into measurement mode when pushing  key in case of mode cancellation.

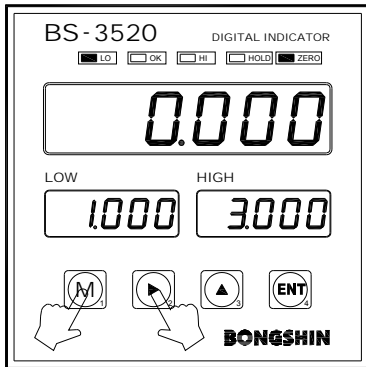

1 It is entered into relay setting value change mode when pushing No.2 key while pushing No.1 key.

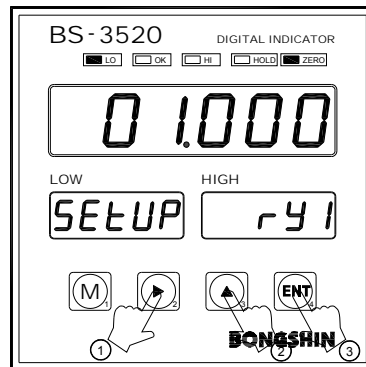

2 When pushing No.4 key after changing RY1 relay setting value with the use of No.2 key and No.3 key, it moves onto next stage. ex) 1.000kg

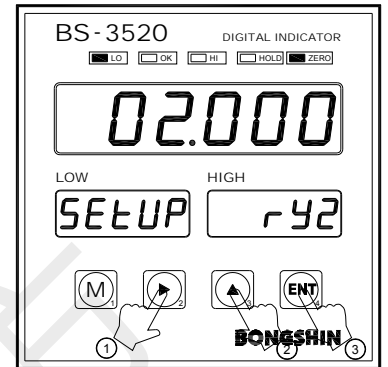

3 When pushing No.4 key after changing RY2 relay setting value with the use of No.2 key and No.3 key, it moves onto next stage. ex) 2.000kg

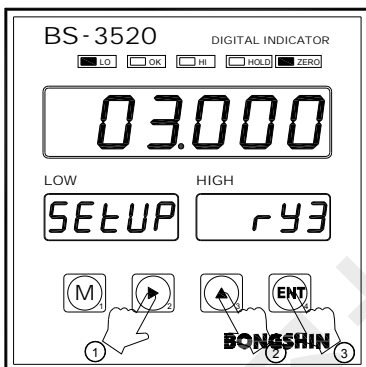

4 When pushing No.4 key after changing RY3 relay setting value with the use of No.2 and No.3 key, it is completed. ex) 3.000kg

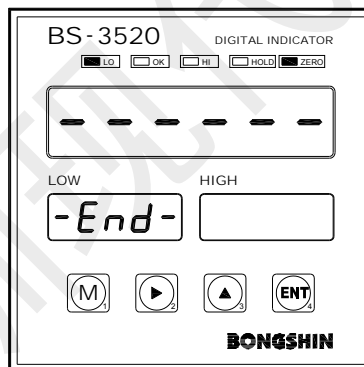

5 Relay setting has been completed and setting value is saved.

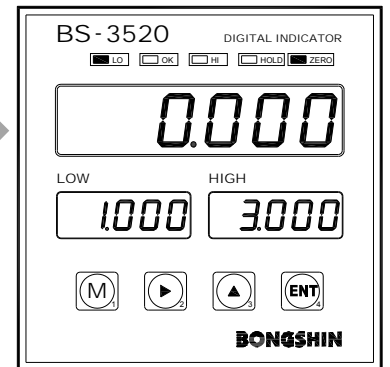

6 It turns into measurement mode status.



- Entry to setting mode is available under key lock status.
- Setting range display may differ based on location of decimal point.
- Although meter display unit is 6 digit, Lo and Hi display unit is 5 digit. Therefore, no display is available for setting value of 6 digit. (minus value setting up to -19999 is available)
- Relay setting value can be initialized at check mode.
- You can exit measurement mode when set only RY1(RY1~RY2) and push No.1 key (M)

9-2 Relay Comparator Mode

9-2-1 Relay operation mode

In comparator output function, there are 4 modes and measurement value and setting value is compared and output from relay output terminal (L1, L2, L3) of rear panel.

Display	Operation Comparator Mode
<i>BAS IC</i>	: Basic limit mode
<i>HY_HI</i>	: High limit mode
<i>HY_Lo</i>	: Low limit mode
<i>HY_LLH</i>	: Low Low High limit mode
<i>nonE</i>	: None

Relation between comparator output and Lo & Hi setting value are as illustrated below.

■ Basic limit mode

Relay output terminal	Output condition
L1 (LO) :	Measurement value < Low setting value
L2 (OK) :	Lo setting value ≤ Measurement value ≤ Hi setting value
L3 (HI) :	Measurement value > Hi setting value

■ High limit mode

Relay output terminal	Output condition
L1 (LO) :	Measurement value ≥ RY1 setting value
L2 (OK) :	Measurement value ≥ RY2 setting value
L3 (HI) :	Measurement value ≥ RY3 setting value

■ Low limit mode

Relay output terminal	Output condition
L1 (LO) :	Measurement value ≤ RY1 setting value
L2 (OK) :	Measurement value ≤ RY2 setting value
L3 (HI) :	Measurement value ≤ RY3 setting value

■ Low Low High limit mode

Relay output terminal	Output condition
L1 (LO) :	Measurement value ≤ RY1 setting value
L2 (OK) :	Measurement value ≤ RY2 setting value
L3 (HI) :	Measurement value ≥ RY3 setting value



- Only Lo & Hi value setting is available from basic limit mode. OK setting is unavailable. In other modes, operation is conducted by RY1, RY2, and RY3 setting value.
- In case of 'None' setting of relay mode, Lo & Hi display window is closed.

9-2-2 Example of relay operation

■ Basic limit mode *6AS IC*

Relay output terminal	Output condition
L1 (LO) :	Measurement value < Lo setting value
L2 (OK) :	Lo setting value ≤ Measurement value ≤ Hi setting value
L3 (HI) :	Measurement value > Hi setting value

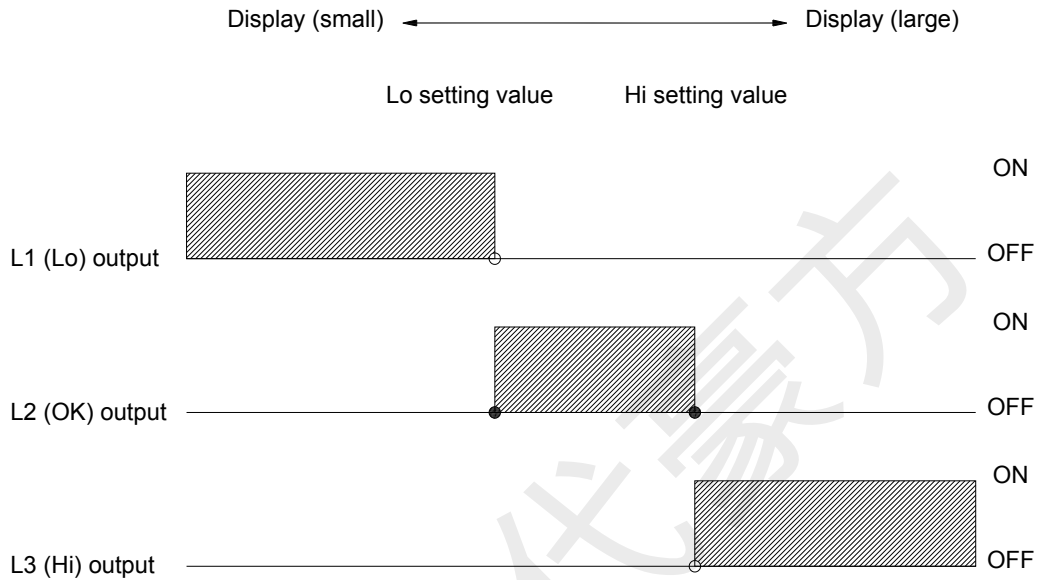

■ High limit mode *HY_HI*

Relay output terminal	Output condition
L1 (LO) :	Measurement value ≥ RY1 setting value
L2 (OK) :	Measurement value ≥ RY2 setting value
L3 (HI) :	Measurement value ≥ RY3 setting value

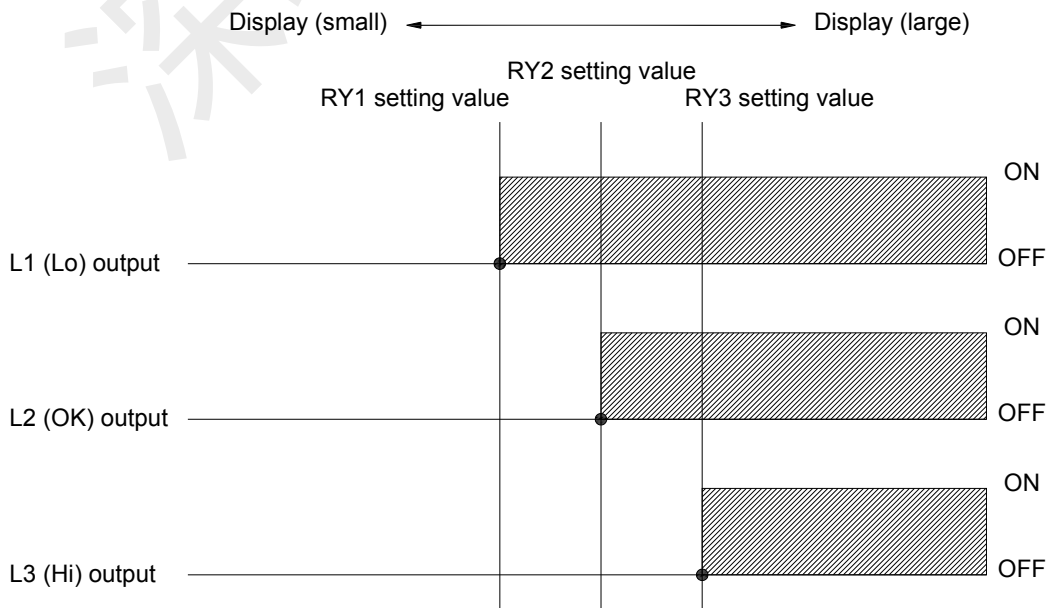

■ Low limit mode **HY_Lo**

Relay output terminal	Output condition
L1 (LO) :	Measurement value \leq RY1 setting value
L2 (OK) :	Measurement value \leq RY2 setting value
L3 (HI) :	Measurement value \leq RY3 setting value

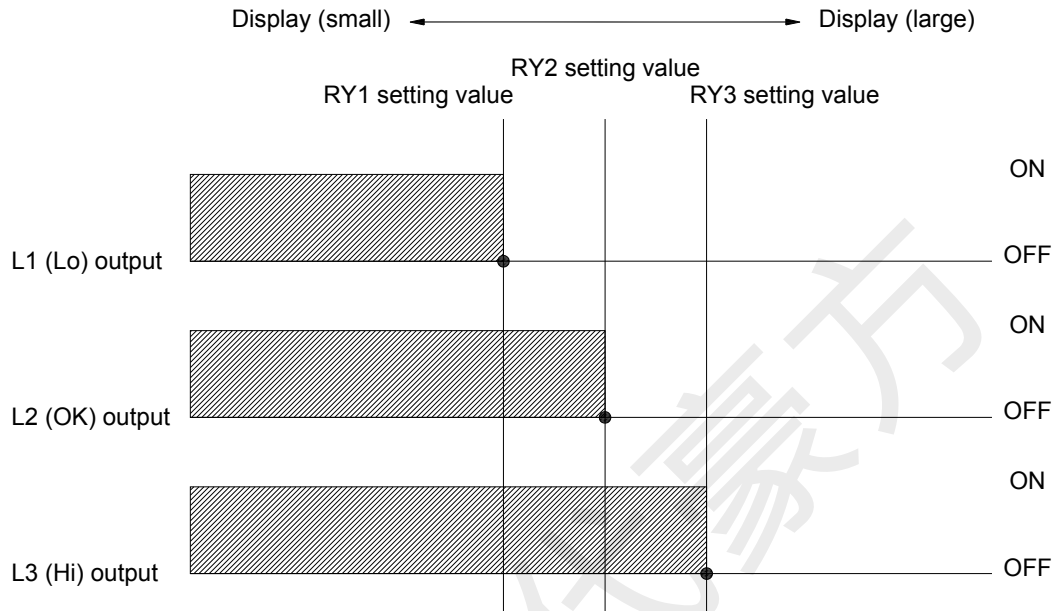

■ Low Low High limit mode **HY_LLH**

Relay output terminal	Output condition
L1 (LO) :	Measurement value \leq RY1 setting value
L2 (OK) :	Measurement value \leq RY2 setting value
L3 (HI) :	Measurement value \geq RY3 setting value

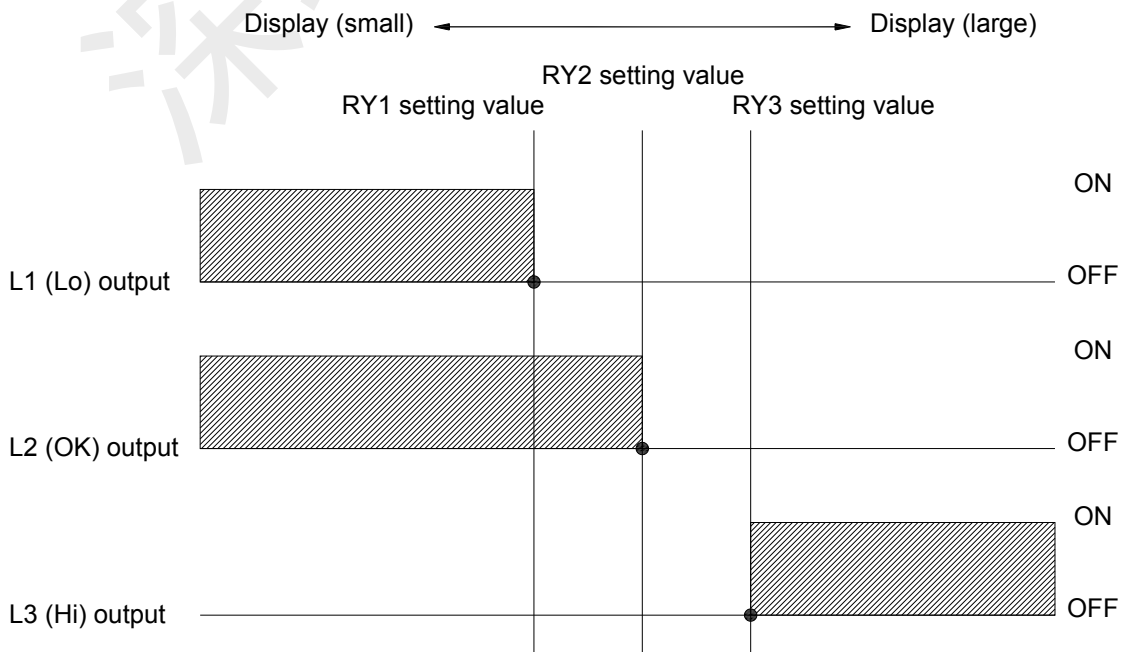

9-3 Comparator Hysteresis Function

9-3-1 Example of hysteresis determination

It is function for output to give ON↔OFF width in order to prevent chattering of output terminal. (a phenomenon in which contact point repeats and operates ON↔OFF).

For instance, it is method when output is turned off when the output is turned on while measurement value exceeds setting value and measurement value is lowered as much as the width of hysteresis.

There are 4 modes of comparator output function as illustrated below and it is output from relay output terminal of rear panel (L1, L2, L3) after comparing the measurement value and setting value. Width of hysteresis is set from function.

1. Basic limit mode

■ Relation between LO and OK

When the measurement value becomes higher than Lo setting value, it immediately turns into OK. When the measurement value is lower than Lo value at OK status, it does not immediately become Lo but it turns into Lo when it became lower than width of hysteresis.

■ Relation between OK and Hi

When the measurement value becomes higher than Hi setting value, it immediately turns into Hi. When the measurement value is lower than Hi value at Hi status, it does not immediately become OK but it turns into Lo when it became lower than width of hysteresis.

Relay Output Terminal	Output Condition
L1 (LO)	Measurement value < Lo setting value Measurement value < Lo setting value + Hysteresis setting value
L2 (OK)	Lo setting value ≤ Measurement value ≤ Hi setting value Lo setting value + Hysteresis setting value ≤ Measurement value ≤ Hi setting value + Hysteresis setting value
L3 (HI)	Measurement value > Hi setting value Measurement value > Hi setting value – Hysteresis setting value

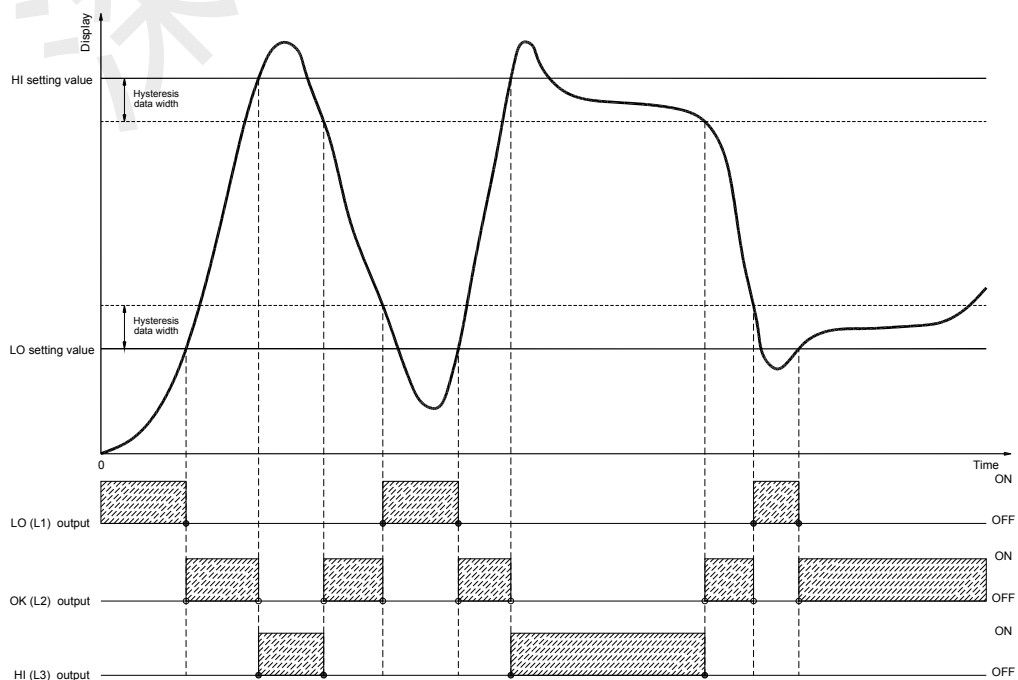

2. High limit mode

In case of RY1(LO), RY2(OK), and RY3(HI), it is turned on when the measurement value becomes higher than setting value and it is turned off when it becomes lower than width of hysteresis.

■ RY1(LO) output

It is immediately turned on when the measurement value becomes higher than RY1(LO) setting value. When the measurement value becomes lower than setting value under On status of RY1(LO), it is not immediately turned off when the measurement value becomes lower than setting value but it is turned off when it becomes lower than width of hysteresis.

■ RY2(OK) output

It is immediately turned on when the measurement value becomes higher than RY2(OK) setting value. When the measurement value becomes lower than setting value under On status of RY2(OK), it is not immediately turned off when the measurement value becomes lower than setting value but it is turned off when it becomes lower than width of hysteresis.

■ RY3(HI) output

It is immediately turned on when the measurement value becomes higher than RY3(HI) setting value. When the measurement value becomes lower than setting value under On status of RY3(HI), it is not immediately turned off when the measurement value becomes lower than setting value but it is turned off when it becomes lower than width of hysteresis.

Relay Output Terminal	Output Condition
L1 (RY1/ LO)	Measurement value \geq RY1 setting value Measurement value \geq RY1 setting value – Hysteresis setting value
L2 (RY2/ OK)	Measurement value \geq RY2 setting value Measurement value \geq RY2 setting value – Hysteresis setting value
L3 (RY3/ HI)	Measurement value \geq RY3 setting value Measurement value \geq RY3 setting value – Hysteresis setting value

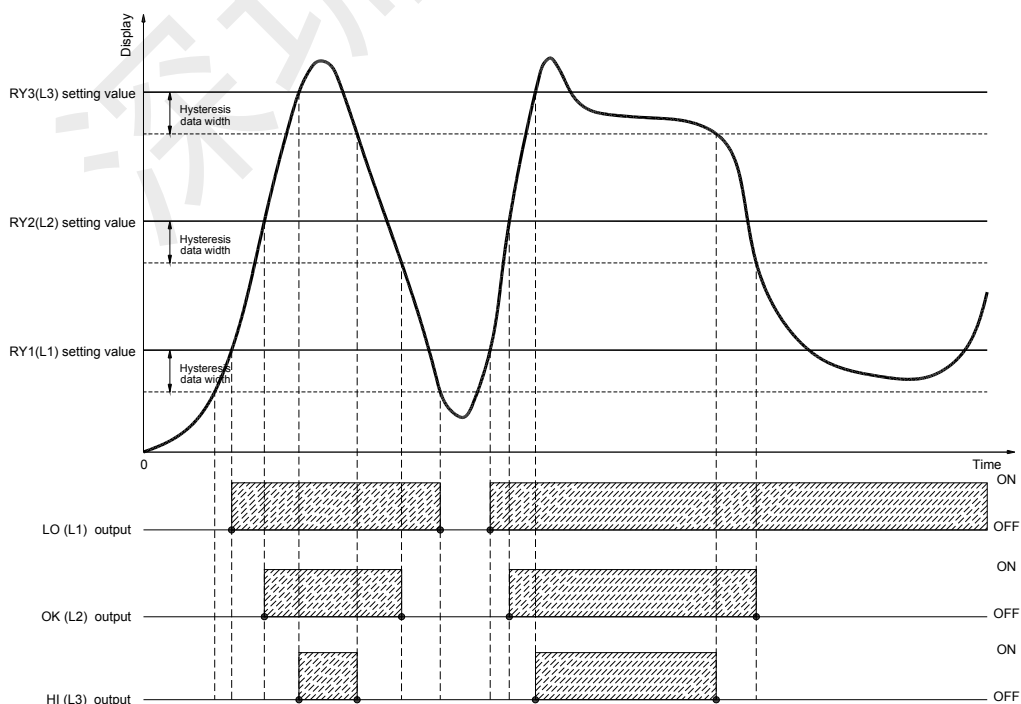

3. Low limit mode

In case of RY1(LO), RY2(OK), and RY3(HI), it is turned on when the measurement value becomes lower than setting value and it is turned off when it becomes higher than width of hysteresis.

■ RY1(LO) output

When the measurement value becomes higher than setting value under On status of RY1(LO), it is not immediately turned off but it is turned off when it becomes higher than width of hysteresis.

It is immediately turned on when the measurement value becomes lower than RY1(LO) setting value.

■ RY2(OK) output

When the measurement value becomes higher than setting value under On status of RY2(OK), it is not immediately turned off but it is turned off when it becomes higher than width of hysteresis.

It is immediately turned on when the measurement value becomes lower than RY2(OK) setting value.

■ RY3(HI) output

When the measurement value becomes higher than setting value under On status of RY3(HI), it is not immediately turned off but it is turned off when it becomes higher than width of hysteresis.

It is immediately turned on when the measurement value becomes lower than RY3(HI) setting value.

Relay Output Terminal	Output Condition
L1 (RY1/ LO)	Measurement value \leq RY1 setting value Measurement value \leq RY1 setting value + Hysteresis setting value
L2 (RY2/ OK)	Measurement value \leq RY2 setting value Measurement value \leq RY2 setting value + Hysteresis setting value
L3 (RY3/ HI)	Measurement value \leq RY3 setting value Measurement value \leq RY3 setting value + Hysteresis setting value

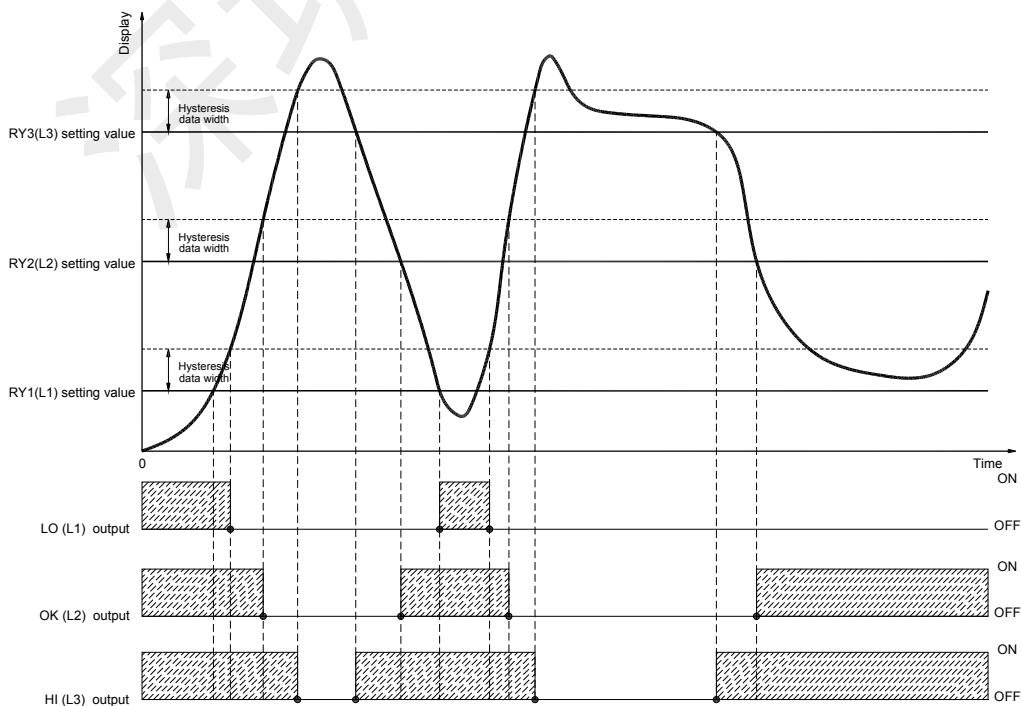

4. Low Low High limit mode

In case of RY1(LO) and RY2(OK), it is turned on when the measurement value becomes lower than setting value and it is turned off when it becomes higher than width of hysteresis.

In case of RY3(HI), it is turned on when the measurement value becomes higher than setting value and it is turned off when it become low as much as width of hysteresis.

■ RY1(LO) output

When the measurement value becomes higher than setting value under On status of RY1(LO), it is not immediately turned off but it is turned off when it becomes higher than width of hysteresis.

It is immediately turned on when the measurement value becomes lower than RY1(LO) setting value.

■ RY2(OK) output

When the measurement value becomes higher than setting value under On status of RY2(OK), it is not immediately turned off but it is turned off when it becomes higher than width of hysteresis.

It is immediately turned on when the measurement value becomes lower than RY2(OK) setting value.

■ RY3(HI) output

It is immediately turned on when the measurement value becomes higher than RY3(HI) setting value.

When the measurement value becomes lower than setting value under On status of RY3(HI), it is not immediately turned off but it is turned off when it becomes lower than width of hysteresis.

Relay Output Terminal	Output Condition
L1 (RY1/ LO)	Measurement value \leq RY1 setting value Measurement value \leq RY1 setting value + Hysteresis setting value
L2 (RY2/ OK)	Measurement value \leq RY2 setting value Measurement value \leq RY2 setting value + Hysteresis setting value
L3 (RY3/ HI)	Measurement value \geq RY3 setting value Measurement value \geq RY3 setting value - Hysteresis setting value

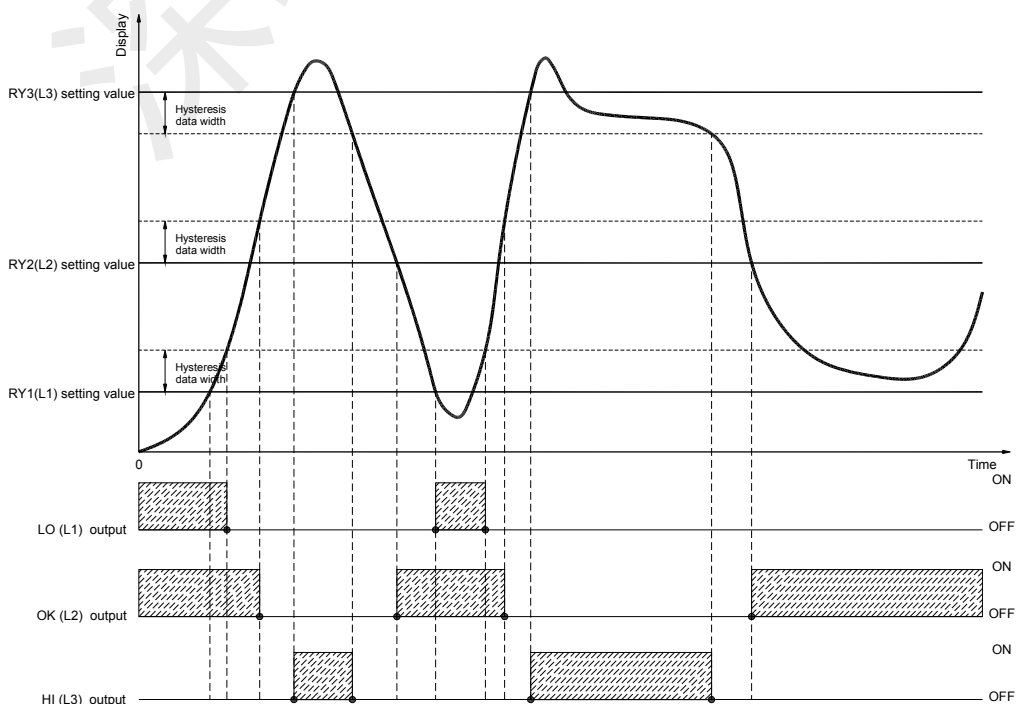

10. Analog Output

There are two types of analog output. Mode selection shall be conducted from function.
 Since it is optional specification, it is equipped upon order.
 When the BCD OPTION is equipped, this mode is not displayed.
 Insulation has been conducted for output circuit and main circuit.

10-1 Analog Output Mode

10-1-1 Analog output selection mode

1. It turns into the mode selection status when key is pushed while pushing key is pushed at measurement status.
2. Relay mode selection item comes out when you push key 11 times at mode selection status.
3. Mode change is available when key or key is pushed at mode selection status.
4. Push key in order to move onto next stage after selecting the analog mode and saving.
5. Push key to cancel the mode and return to measurement mode.

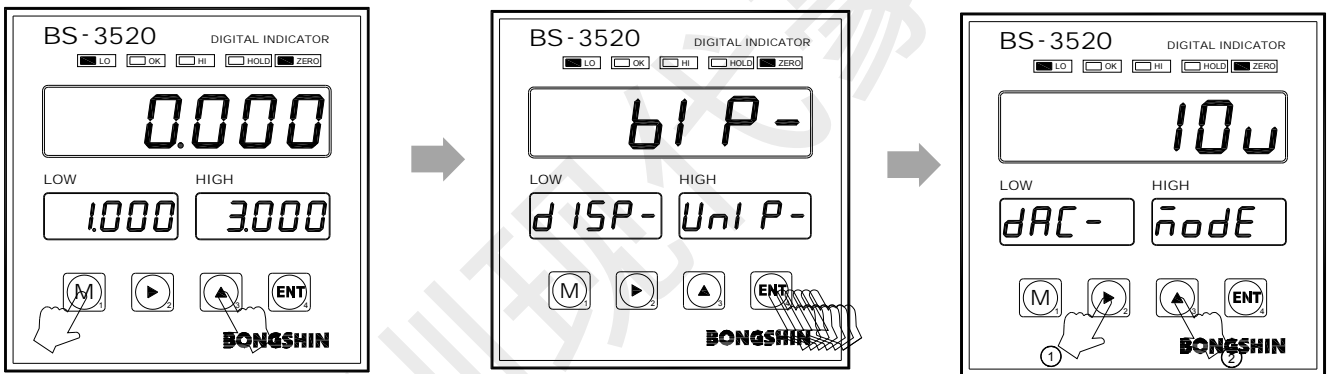

- 1 It is entered into function mode when pushing No.3 key while pushing No.1 key.
- 2 It moves onto analog mode selection stage when pushing No.4 key 11 times.
- 3 Output mode can be changed by pushing either No.2 or No.3 key.

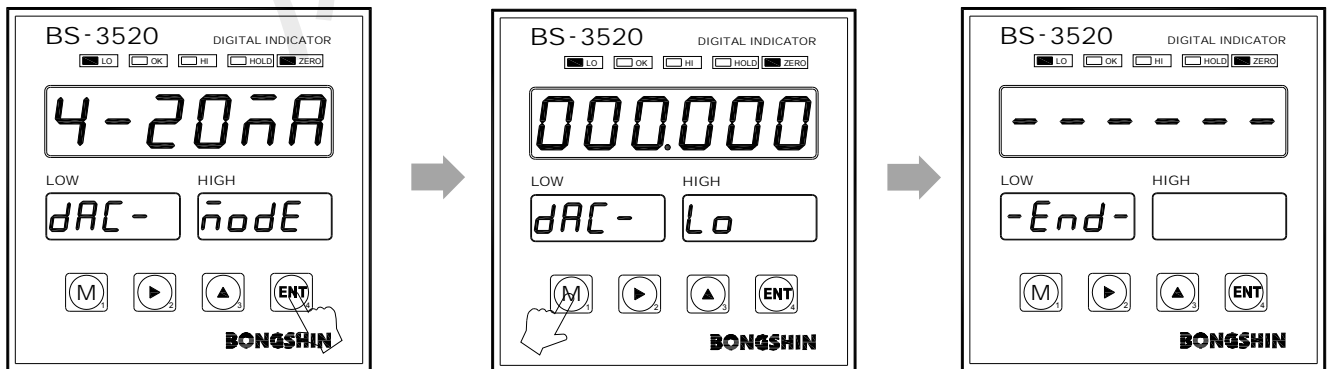

- 4 When pushing No.4 key after mode change, it moves onto next stage after saving selected item.
- 5 It is turned into measurement mode when pushing No.1 key.
- 6 Function setting has been completed and it is turned into measurement mode status.

10-2 Analog output specification and connection method (DAV, DAI)

For DAV(DAI) output, the measurement value is converted into D/A and output as analog voltage (current).

Output range include 0~5V, 0~10V, 0 ~ ±5V, 0 ~ ±10V, 0~20mA, and 4~20mA.

Output scaling and minute calibration is set from function.

Frequency trait is based on display conversion speed setting of function.

10-2-1 Specification

Range of rated output	-10 V ~ +10 V	4 ~ 20mA
Range of max output :	-12.0 V ~ +12.0 V	0 ~ 24mA
D/A conversion speed :	1000 times/sec	1000 times/sec
Valid resolution :	1/10000	1/10000
Zero drift :	±1 mV/°C typ.	±0.5uA/°C typ.
Gain drift :	±100ppm/°C typ.	±100ppm/°C typ.
Non-linearity :	Within ±0.05%F.S.	Within ±0.05%F.S.
Load resistance ::	5 kΩ or higher	500Ω or higher

10-2-2 Connection method (DAV)

Terminal No.	Contents
VOLT +	Voltage output +
VOLT -	Voltage output -

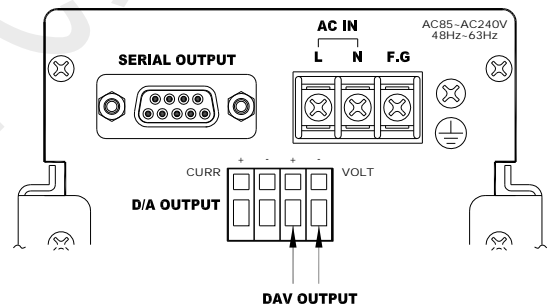

10-2-3 Connection method (DAI)

Terminal No.	Contents
CURR +	Current output +
CURR -	Current output -

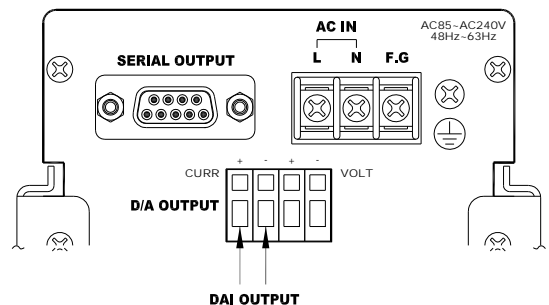

- Analog Output is to convert measurement value into D/A for output and display conversion speed shall be changed from function setting in case of wanting 1000 times/sec output. It is output based on display conversion speed of function setting.
- In case of DAI Analog Output, (-) display value is not output.
- Output at function mode entry maintains previous value before entry and there is no output change.
- **Voltage and current output cannot be used at once.** Either voltage or current mode shall be selected from function setting for use. (it is different output terminal).

10-3 Analog Output Zero & Span Calibration

Measurement equivalent to 0V(0mA, 4mA), and 10V(20mA) of DAV (DAI) output is set.

Output scaling is set from function.

This mode is not displayed with the equipment of BCD OPTION.

10-3-1 Analog output zero & span calibration

1. It turns into the mode selection status when key is pushed while pushing key is pushed at measurement status.
2. Relay mode selection item comes out when you push key 12 times at mode selection status.
3. Mode change is available when key or key is pushed at mode selection status.
4. Push key in order to move onto next stage after selecting the analog output setting and saving.
5. Push key to cancel the mode and return to measurement mode.

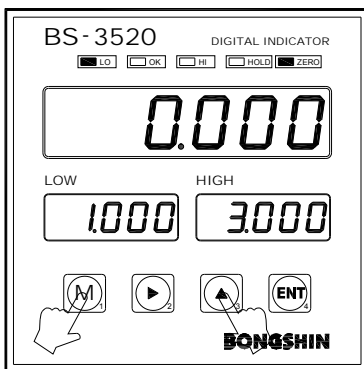

- 1** It is entered into function mode when pushing No.3 key while pushing No.1 key.

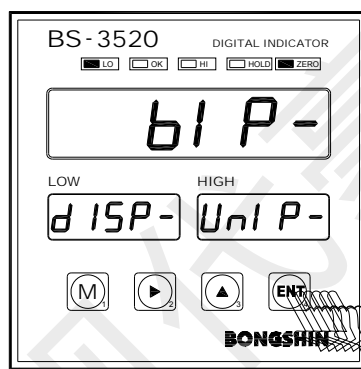

- 2** It moves onto analog Lo output setting stage when pushing No.4 key 12 times.

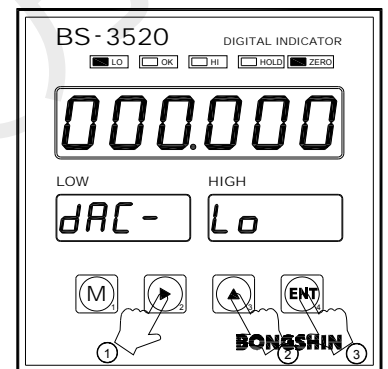

- 3** It moves onto next stage when pushing No.4 key after changing Lo input key and saving with the use of No.2 and No.3 key.

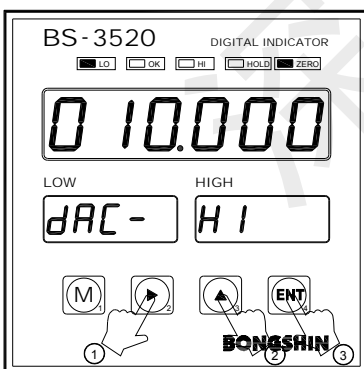

- 4** It moves onto next stage when pushing No.4 key after changing Hi output value with the use of No.2 and No.3 key.

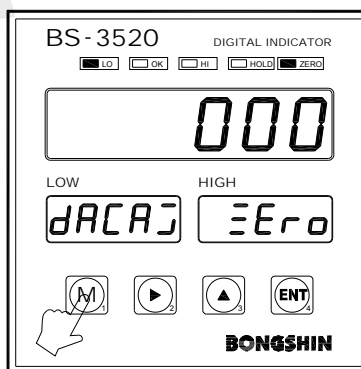

- 5** It is changed into measurement mode when pushing No.1 key upon completion of setting.

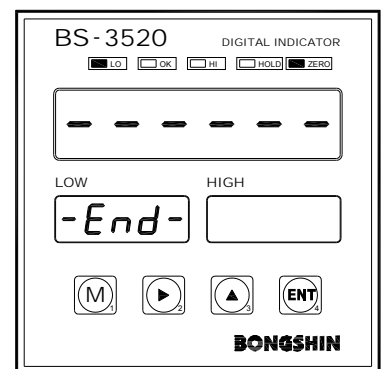

- 6** Function setting has been completed and it is changed into measurement mode status after saving setting value.



- Entry to setting mode is unavailable under key lock status thus it shall be executed after key lock cancellation.
- Setting range display may differ based on location of decimal point.
- For analog output, output is maintained with value under hold status even at hold status.
- Function setting value can be initialized at check mode.

10-3-2 Analog output graph (DAV)

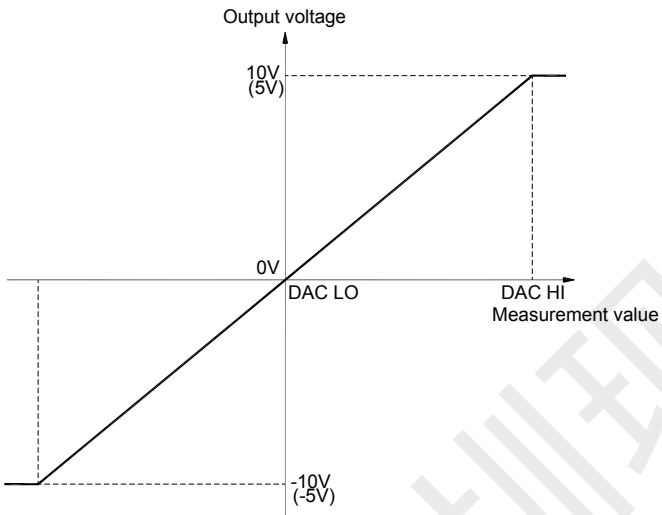
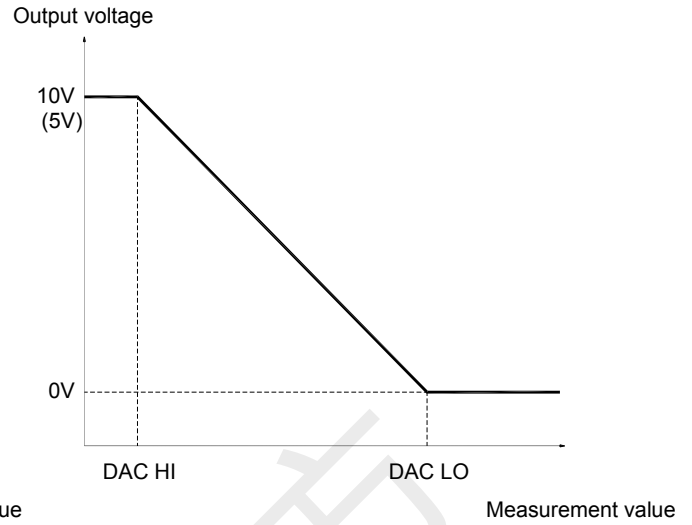
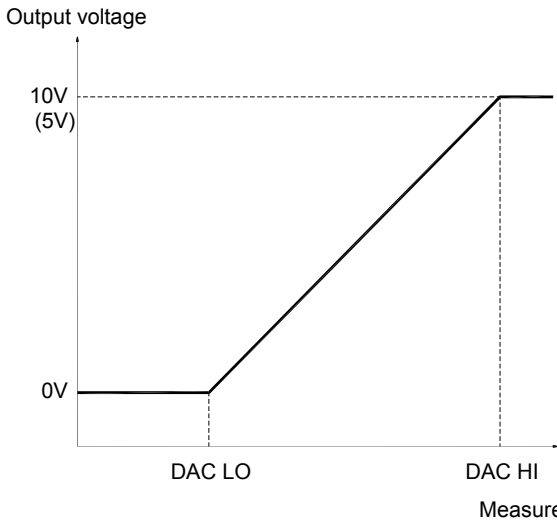

- In case of setting DAC LO and DAC HI as same value, output does not increase from 0V
- Reverse output is only applicable at 0~10(5V) setting. It is not applicable at 0~±5V, 0~±10V, 0~20mA, 4~20mA output. For reverse output, in case of setting DA Lo setting value and DAC Hi setting value is each set as 10.000 and 0.000, 0V and 10V (5V) is each output from 10.000 display value and 0.000 value.

10-3-3 Analog output graph (DAI)

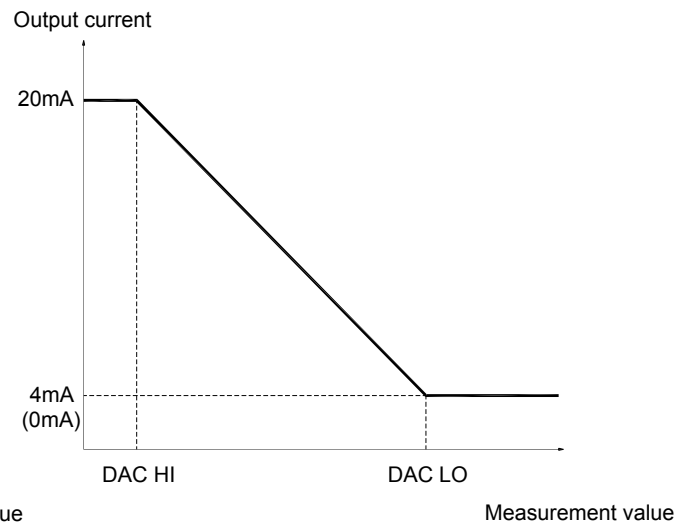
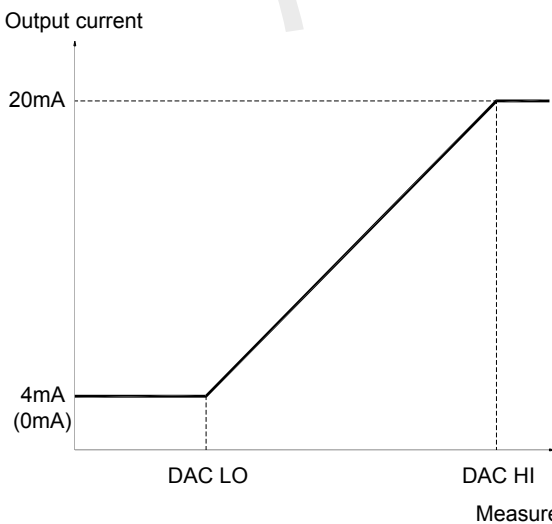

10-4 Analog output zero and span minute calibration

Minute calibration is conducted for measurement value equivalent to 0V(0mA, 4mA), and 10V(20mA) of DAV (DAI) output.

Output minute calibration is set from function.

This mode is not displayed with the equipment of BCD OPTION.

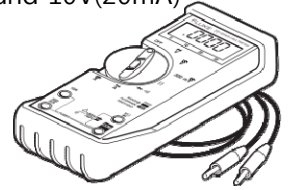

Warning

This mode shall be used only when there is lack of accuracy even after analog output zero and span calibration. High precision digital multi-meter is necessary in order to conduct calibration since it controls inner calibration factor. There may be deterioration in performance when meter with low precision is used.

10-4-1 Analog output zero & span minute calibration

1. It turns into the mode selection status when key is pushed while pushing key is pushed at measurement status.
2. Relay mode selection item comes out when you push key 14 times at mode selection status.
3. Mode change is available when key or key is pushed at mode selection status.
4. Push key in order to move onto next stage after selecting the analog output setting value and saving.
5. Push key to cancel the mode and return to measurement mode.

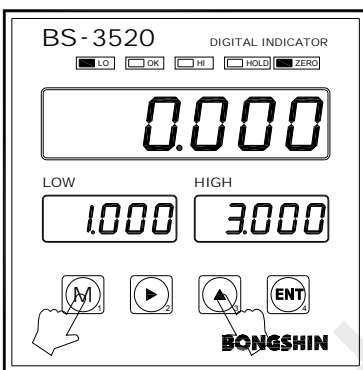

1 It is entered into function mode when pushing No.3 key while pushing No.1 key.

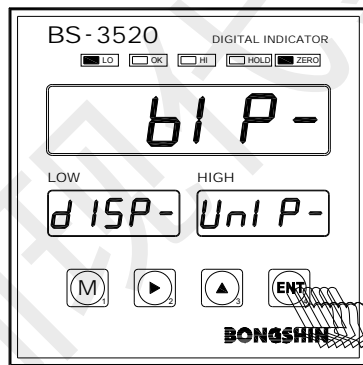

2 It moves onto stage for minute calibration of analog zero output value when pushing No.4 key 14 times.

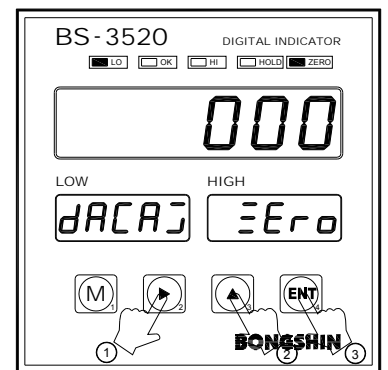

3 It moves onto next stage when pushing No.4 key after changing zero output value and saving with the use of No.2 and No.3 key.

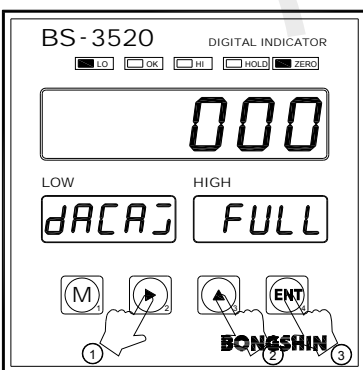

4 It moves onto to next stage when pushing No.4 key when changing span output value with the use of No.2 and No.3 key.

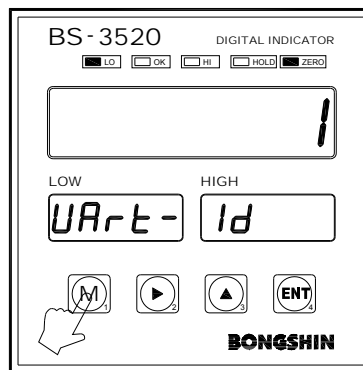

5 It is changed into measurement mode when pushing No.1 key upon setting completion.

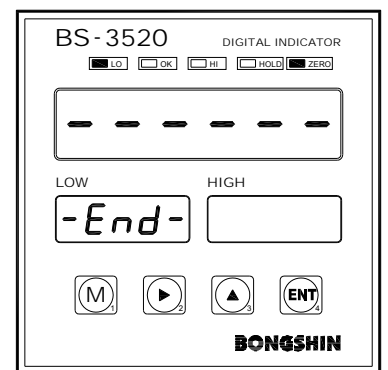

6 Function setting has been completed and it is changed into measurement mode status after saving the setting value.

10-4-2 Analog output zero & span minute calibration range

Output mode	Range of minute calibration	Minute calibration setting value	Output change width for minute calibration
0 ~ 10V output	0 ~ 9999 (-9999)	0	0V
		10 (-10)	0.002V increase (decrease)
		20 (-20)	0.004V increase (decrease)
		~	~
		100 (-100)	0.02V increase (decrease)
0 ~ ±10V output	-9999 ~ 9999	0	0V
		10 (-10)	0.004V increase (decrease)
		20 (-20)	0.008V increase (decrease)
		~	~
		100 (-100)	0.04V increase (decrease)
0 ~ 5V output	0 ~ 9999 (-9999)	0	0V
		10 (-10)	0.001V increase (decrease)
		20 (-20)	0.002V increase (decrease)
		~	~
		100 (-100)	0.01V increase (decrease)
0 ~ ±5V output	-9999 ~ 9999	0	0V
		10 (-10)	0.002V increase (decrease)
		20 (-20)	0.004V increase (decrease)
		~	~
		100 (-100)	0.02V increase (decrease)
4 ~ 20mA output	-9999 ~ 9999	0	0 mA
		10 (-10)	0.004 mA increase (decrease)
		20 (-20)	0.008 mA increase (decrease)
		~	~
		100 (-100)	0.04 mA increase (decrease)
0 ~ 20mA output	0 ~ 9999 (-9999)	0	0 mA
		10 (-10)	0.003 mA increase (decrease)
		20 (-20)	0.006 mA increase (decrease)
		~	~
		100 (-100)	0.03 mA increase (decrease)

Calibration range of voltage output is max ±4.0V and current output is ±4.0mA.



- Entry to setting mode is unavailable under Key Lock status thus it shall be executed after key lock cancellation.
- Implementation of minute calibration shall be used only when there is lack of accuracy with general scaling.
There may be a lowering of accuracy when there is a change in the adjusted setting value at forwarding by our company.
- Calibration of output voltage (current) shall be conducted while viewing digital multi-meter.
- **Since there may be a difference in calibration factor of each device, it is recommended that calibration factor shall be recorded in-advance when the change is made.**
- At this mode, minute calibration is available for only 0V(0mA, 4mA) and 10V(20mA).
In case of using 0~20mA mode, minute calibration of 0mA is conducted only with (+) value and minute calibration of 20mA is conducted only with (-) value.
- When you continuously push No.2 or No.3 key at minute calibration, figure is quickly increased and decreased by 10.
- Function setting value can be initialized at check mode.

11. BCD Output

BCD output is an interface to output display value as data of BCD code.

It is used to process control, collection, record, and others with access to PLC.

Usage shall be selected at check mode.

Since it is optional specification, it shall be equipped at the order.

11-1 BCD Parallel Output

11-1-1 Specification

- Output internal voltage : 35 V
- Max current : 30mA
- Max On voltage : 0.7V
- Output specification : Open collector output
- Connector specification : D-SUB 37 pin Male (Female for cable side)

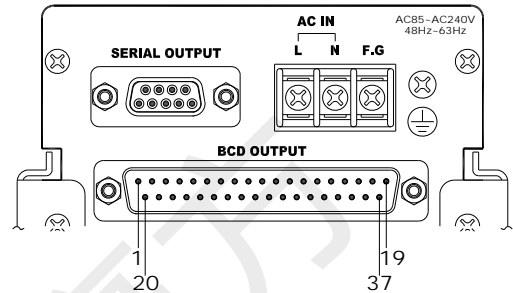

11-1-2 Connection method

Pin No.	Direction	BCD code	Pin No.	Direction	BCD code
1	O.COM	Output common	20	Output	4
2	Output	1	21	Output	8
3	Output	2	22	Output	1
4	Output	4	23	Output	2
5	Output	8	24	Output	4
6	Output	1	25	Output	8
7	Output	2	26	Output	Polarity
8	Output	4	27	Output	Decimal point 10 ¹
9	Output	8	28	Output	Decimal point 10 ²
10	Output	1	29	Output	Decimal point 10 ³
11	Output	2	30	Output	Decimal point 10 ⁴
12	Output	4	31	Output	Decimal point 10 ⁵
13	Output	8	32	Output	STABLE
14	Output	1	33	Output	OVER
15	Output	2	34	O.COM	Output common terminal
16	Output	4	35	Input	HOLD (DC5~24V)
17	Output	8	36	Input	ZERO (DC5~24V)
18	Output	1	37	I.COM	Input common terminal
19	Output	2			



- Output is conducted in association with display speed.
- **Output common can be used regardless of (+) and (-) common.**
- Operation is conducted when authorizing voltage to Pin35, 36, and 37 input and if not it is cancelled.

12. Serial Output

Serial output is an interface which conducts the output of display value as serial data.

It is used to process control, collection, record, and others with access to PLC.

Various setting shall be selected from function mode.

Since RS-232C & RS-422/485 is included in standard specification, basic equipment is conducted.

12-1 RS-232C/422/485 Serial Interface

12-1-1 Specification

	RS-232C	RS-422/485
Transmission Method	Full duplex, Asynchronous	Semi duplex
Transmission Distance	Max 15m	Max 1km
Transmission Speed	1200 bps ~ 115200 bps	
Data bit	7, 8 bits	
Parity bit	None, Even, Odd	
Stop bit	1bit	
Use code	ASCII	
Terminator	STX, ETX (STX: 02H, ETX: 03H)	
No. of max connection	1	Max 32sets (RS-422:10sets)
Connector specification	D-SUB 9 pin Female (male for cable side)	

12-1-2 Connection method

For RS-232C

Pin No.	Signal name	Direction	Description
2	TXD	Output	Transmit data
3	RXD	Input	Receive data
5	SG	-	Signal ground
Others			No connection
Casing			Shield

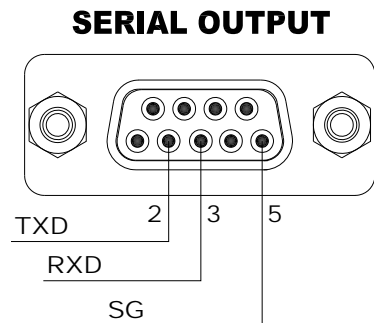

For RS-422

Pin No.	Signal name	Direction	Description
6	RX+	Input	Receive data
7	RX-	Input	Receive data
8	Tx+	Output	Transmit data
9	TX-	Output	Transmit data
Others			No connection
Casing			Shield

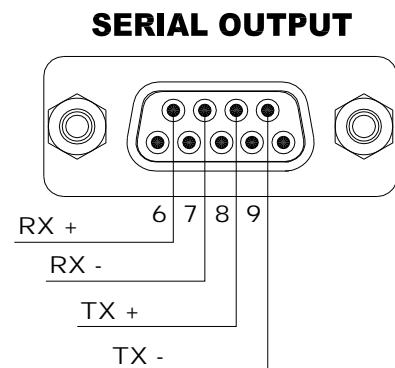

Warning : In case of using RS-422, change shall be made from function setting.

For RS-485

Pin No.	Signal name	Direction	Description
6	T(R)X+	TRa	RS-485 line A
7	T(R)X-	TRb	RS-485 line B
Others			No connection
Casing			Shield

12-1-3 Example of RS-485 connection

1. 1:1 connection with master

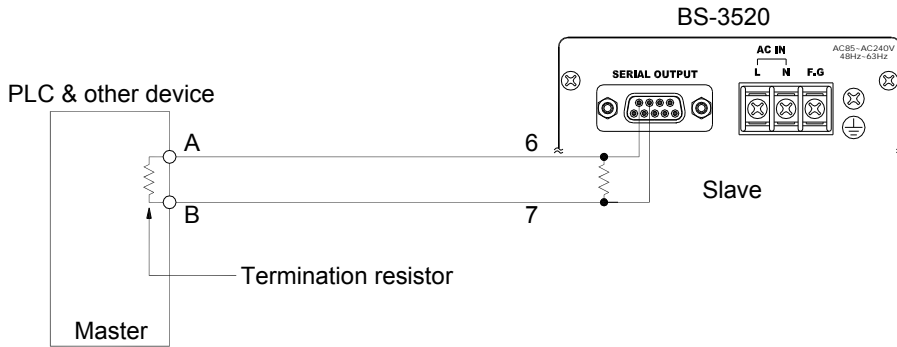

- Shield cable and twist pair cable shall be used.
- Longitudinal resistance shall be exerted to both ends of wiring. (100Ω ~ 120Ω, 1/2W~2W)
- There may be a reverse display of A and B for some master equipment.
Connect by changing A and B in case communication is unavailable.

2. Multiple connection of BS-3520 to 1 master

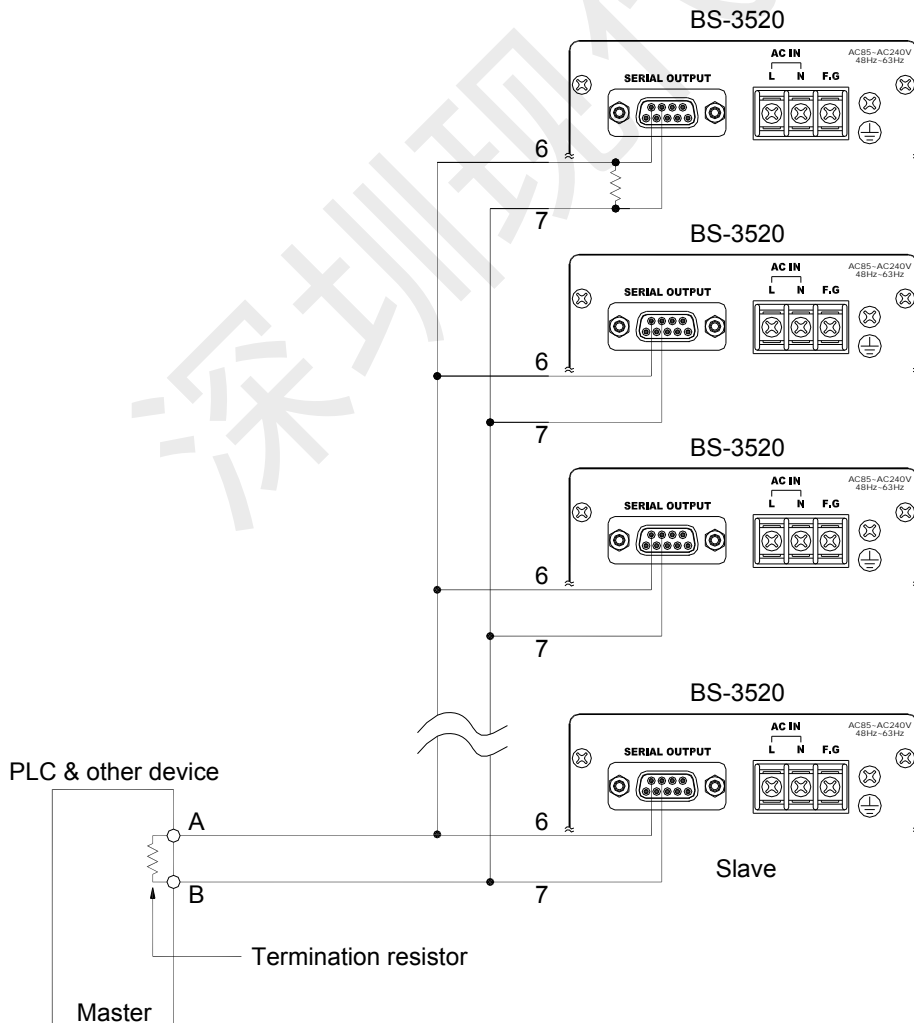

12-2 Format

12-2-1 Stream Mode

	ID			Sign	Weight Data						Decision	
1	2	3	4	5	6	7	8	9	10	11	12	13
<STX>	0	1	±	1	2	3	.	4	5	6	L	<ETX>
<STX>	0	1	±	1	2	3	.	4	5	6	O	<ETX>
<STX>	0	1	±	1	2	3	.	4	5	6	H	<ETX>
<STX>	0	1	±	1	2	3	4	5	6	.	H	<ETX>

Warning : When there is no decimal point in display, decimal point is received at the end of weight data.

12-2-2 Command mode

1. Command to request data

Current value is requested.

Command example

	ID			Command	
1	2	3	4	5	
<STX>	0	1	R	<ETX>	
02	30	31	52	03	

Response example (ASCII)

	ID			Sign	Weight data						Decision	
1	2	3	4	5	6	7	8	9	10	11	12	13
<STX>	0	1	±	1	2	3	.	4	5	6	L	<ETX>
<STX>	0	1	±	1	2	3	.	4	5	6	O	<ETX>
<STX>	0	1	±	1	2	3	.	4	5	6	H	<ETX>
<STX>	0	1	±	1	2	3	4	5	6	.	H	<ETX>

Warning : When there is no decimal point in display, decimal point is received at the end of weight data.

Response example (Hexa)

	ID			Sign	Weight data						Decision	
1	2	3	4	5	6	7	8	9	10	11	12	13
02	30	31	2B	31	32	33	2E	34	35	36	4C	03
02	30	31	2B	31	32	33	2E	34	35	36	4F	03
02	30	31	2B	31	32	33	2E	34	35	36	48	03
02	30	31	2B	31	32	33	34	35	36	2E	48	03



- Output is conducted same as flickering of LED.

L : RY1(LO) relay operation

O : RY2(OK) relay operation

H : RY3(HI) relay operation

A : RY1(LO), RY2(OK) relay operation

B : RY2(OK), RY3(HI) relay operation

C : RY1(LO), RY3(HI) relay operation

F : RY1(LO), RY2(OK), RY3(HI) relay operation

N : RY1(LO), RY2(OK), RY3(HI) relay OFF or None of relay mode

2. Zero command

Zero command is executed.

Command example

	ID		Command	
1	2	3	4	5
<STX>	0	1	Z	<ETX>
02	30	31	5A	03

3. Hold ON command

Hold is commenced.

Command example

	ID		Command	
1	2	3	4	5
<STX>	0	1	H	<ETX>
02	30	31	48	03

4. Hold OFF command

Hold is cancelled.

Command example

	ID		Command	
1	2	3	4	5
<STX>	0	1	C	<ETX>
02	30	31	43	03

深圳现代豪方

5. Command to send the Low/High limit values

Output of set Lo/Hi value is conducted.

Command example

	ID			COMMAND				
1	2	3	4	5	6	7	8	
<STX>	0	1	R	L	O	R	<ETX>	
<STX>	0	1	R	H	I	R	<ETX>	
<STX>	0	1	R	Y	1	R	<ETX>	
<STX>	0	1	R	Y	2	R	<ETX>	
<STX>	0	1	R	Y	3	R	<ETX>	

Response example (with decimal point)

	ID			COMMAND			Sign	VALUE					
1	2	3	4	5	6	7	8	9	10	11	12	13	14
<STX>	0	1	R	L	O	+	0	1	.	0	0	0	<ETX>
<STX>	0	1	R	H	I	+	0	3	.	0	0	0	<ETX>
<STX>	0	1	R	Y	1	+	0	1	.	0	0	0	<ETX>
<STX>	0	1	R	Y	2	+	0	2	.	0	0	0	<ETX>
<STX>	0	1	R	Y	3	+	0	3	.	0	0	0	<ETX>

Response example (without decimal point): number of digits is reduced by one.

	ID			COMMAND			Sign	VALUE					
1	2	3	4	5	6	7	8	9	10	11	12	13	
<STX>	0	1	R	L	O	+	0	1	0	0	0	<ETX>	
<STX>	0	1	R	H	I	+	0	3	0	0	0	<ETX>	
<STX>	0	1	R	Y	1	+	0	1	0	0	0	<ETX>	
<STX>	0	1	R	Y	2	+	0	2	0	0	0	<ETX>	
<STX>	0	1	R	Y	3	+	0	3	0	0	0	<ETX>	



- Data reception, command, and response toward command differ based on ID setting and location of decimal point.
- Serial output and command setting can be conducted even under hold status (only zero command cannot be operated)
- Command setting is available even under stream mode setting (operation of zero command is also available) However, since data may be broken due to overlapping thus it would be better not to use command under stream mode status.
- Data reception or response is unavailable during entry to function mode (same for stream mode).
- **Response to command is unavailable during entry to function mode, calibration mode, and relay mode. (same for stream mode)**
- In case of using RS-232C/422 serial output, command is operated even under stream mode. (operation is unavailable for RS-485).
- **In case of using RS-422, RS-485 shall be changed into RS-422 at function mode.**

6. Command to set Low/High limit values

Lo/Hi value shall be set.

For sign setting, both (+) and (-) are available.

Command example (with decimal point)

	ID		COMMAND				Sign	VALUE						
1	2	3	4	5	6	7	8	9	10	11	12	13	14	
<STX>	0	1	R	L	O	+	0	1	.	0	0	0	<ETX>	
<STX>	0	1	R	H	I	+	0	3	.	0	0	0	<ETX>	
<STX>	0	1	R	Y	1	+	0	1	.	0	0	0	<ETX>	
<STX>	0	1	R	Y	2	+	0	2	.	0	0	0	<ETX>	
<STX>	0	1	R	Y	3	+	0	3	.	0	0	0	<ETX>	

Warning: No change can be made for display without decimal point.

(only current setting value is transmitted).

Command example (without decimal point): Number of digit is reduced by one.

	ID		COMMAND				Sign	VALUE					
1	2	3	4	5	6	7	8	9	10	11	12	13	
<STX>	0	1	R	L	O	+	0	1	0	0	0	<ETX>	
<STX>	0	1	R	H	I	+	0	3	0	0	0	<ETX>	
<STX>	0	1	R	Y	1	+	0	1	0	0	0	<ETX>	
<STX>	0	1	R	Y	2	+	0	2	0	0	0	<ETX>	
<STX>	0	1	R	Y	3	+	0	3	0	0	0	<ETX>	

Warning: No change can be made for display with decimal point.

(only current setting value is transmitted).

Response example (with decimal point)

	ID		COMMAND				Sign	VALUE						
1	2	3	4	5	6	7	8	9	10	11	12	13	14	
<STX>	0	1	R	L	O	+	0	1	.	0	0	0	<ETX>	
<STX>	0	1	R	H	I	+	0	3	.	0	0	0	<ETX>	
<STX>	0	1	R	Y	1	+	0	1	.	0	0	0	<ETX>	
<STX>	0	1	R	Y	2	+	0	2	.	0	0	0	<ETX>	
<STX>	0	1	R	Y	3	+	0	3	.	0	0	0	<ETX>	

Response example (without decimal point): Number of digit is reduced by one.

	ID		COMMAND				부호	VALUE					
1	2	3	4	5	6	7	8	9	10	11	12	13	
<STX>	0	1	R	L	O	+	0	1	0	0	0	<ETX>	
<STX>	0	1	R	H	I	+	0	3	0	0	0	<ETX>	
<STX>	0	1	R	Y	1	+	0	1	0	0	0	<ETX>	
<STX>	0	1	R	Y	2	+	0	2	0	0	0	<ETX>	
<STX>	0	1	R	Y	3	+	0	3	0	0	0	<ETX>	



- Data reception, command, and response toward command differ based on ID setting and location of decimal point.
- Serial output and command setting can be conducted even under hold status. (only zero command cannot be operated).
- Command setting is available even under stream mode status. (operation of zero command is also available)
- Lo setting is operated same as RY1 setting. Only difference lies in response format toward command.
- Hi setting is operated same as RY3 setting. Only difference lies in response format toward command.

12-2-3 AND Format

In case of AND format setting, command mode is same as **12-2-2 command mode**.

Transmission Method :	Full duplex, Asynchronous
Transmission Speed :	1200 bps ~ 115200 bps
Data bit :	7, 8 bits
Parity bit :	None, Even, Odd
Stop bit :	1 bit
Use code :	ASCII
Terminator :	CR, LF (CR: 0DH, LF: 0AH)
Connector specification :	D-SUB 9 pin Female (male for cable side)

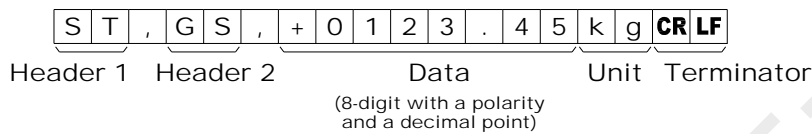

	ASCII code	Hexadecimal	Description
Header 1	ST	[53 54]	Stable
	UN	[55 4E]	Unstable
	OL	[4F 4C]	Overload
Header 2	GS	[47 53]	Gross weight
	NT	[4E 54]	Net weight
Separator	,	[2C]	
Data (ASCII code)	0 to 9	[30 to 39]	
	+	[2B]	
	-	[2D]	
	SP (space)	[20]	
	.	[2E]	
Unit	kg	[6B 67]	kg
Terminator	CR	[0D]	
	LF	[0A]	

12-2-4 ASCII Code

	Lower bits								
	0	1	2	3	4	5	6	7	
Upper bits	0			Space	0	@	P	Space	p
	1			!	1	A	Q	a	q
	2			"	2	B	R	b	r
	3			#	3	C	S	c	s
	4			\$	4	D	T	d	t
	5			%	5	E	U	e	u
	6			&	6	F	V	f	v
	7			'	7	G	W	g	w
	8			(8	H	X	h	x
	9)	9	I	Y	i	y
	A	LF		*	:	J	Z	j	z
	B			+	;	K	[k	{
	C			,	<	L	¥	l	
	D	CR		-	=	M]	M	}
	E			.	>	N	^	N	●
	F			/	?	O	_	o	○

13. Check Mode

It is a mode to check load cell output (mV), check DAC(DAI) output, select option setting, and initialize setting value.

13-1 Operation for each check mode

13-1-1 How to enter check mode

1. It turns into the setting available status when key is pushed while pushing key is pushed at measurement status.
2. Push key in order to move onto next stage at mode selection status.
3. Mode change and setting value change is available when key or key is pushed at mode selection status.
4. Push key to cancel the setting and return to measurement mode for mode cancellation.

At the mode cancelation, the setting until previous stage of cancellation is saved.

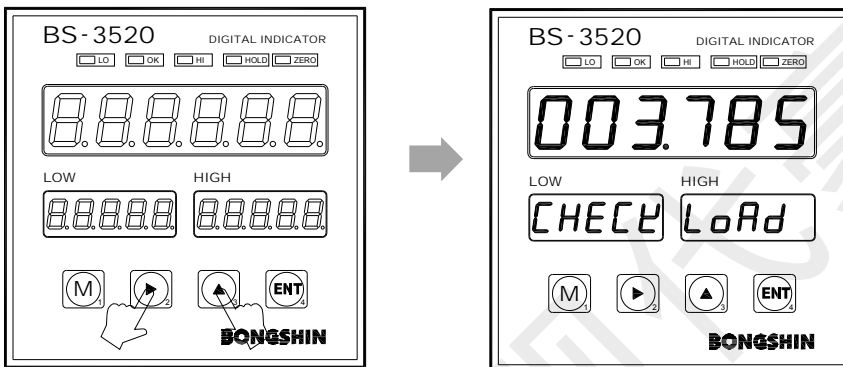

- 1** It is entered into mode when turning the power on while pushing No.2 and No.3 key under power off status.

Current load cell output voltage is displayed. 000.000mV is displayed under no load and mV is differently displayed based on dead load Load cell shall be examined with the display of higher than 015.000mV or display of ovEr(OVER).

13-1-2 Load cell output voltage check

It is mode to check load cell output voltage. Load cell output voltage is displayed on meter display unit. Load cell mV voltage can be checked without digital multi-meter. (ex: 003.785mV)

There is an increase in voltage when load is exerted to load cell. Measurement of up to 035.000mV is available and Over is displayed for value exceeding it. Examine the load cell when displaying load cell output voltage of 015.000mV or higher. .

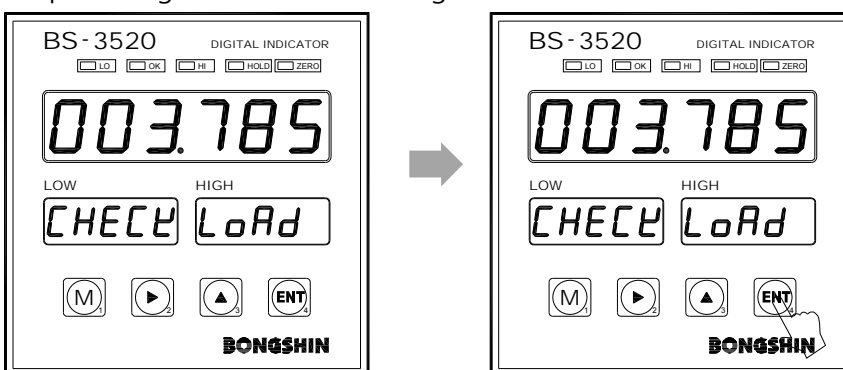

- 2** Abnormality can be checked by examining load cell output voltage.

- 3** It moves onto next stage when pushing No.4 key for 2 sec and push No.1 key for cancellation.

13-1-3 Optional output (DAC, BCD) selection mode

It is a mode to select optional output.

It shall be selected in case of equipment with change in option.

In case of using analog output voltage (current) and BCD parallel output, it shall be changed into DAC and BCD respectively.

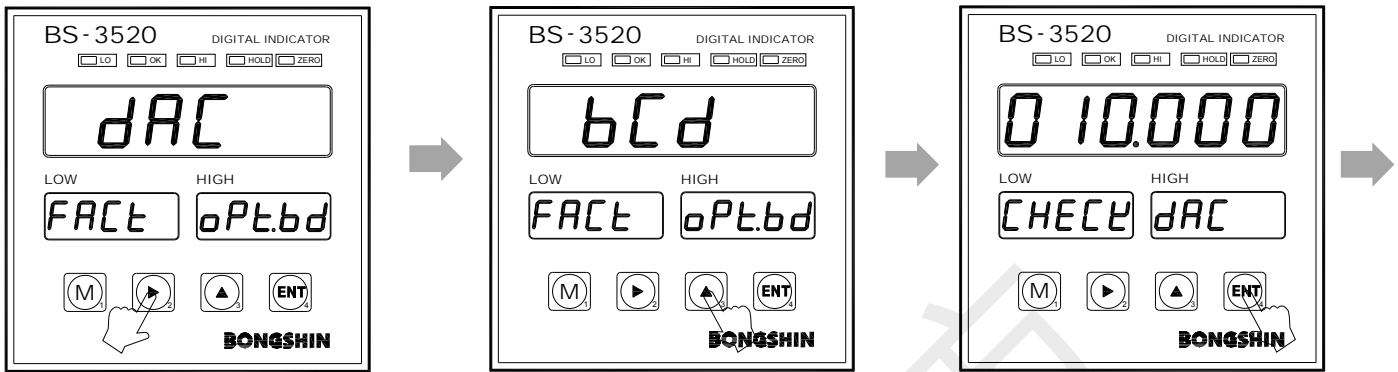

4 Select optional output with the use of No.2 and No.3 key.

Select either BCD or DAC output. Selection shall be made based on equipped option.

5 It moves onto next stage when pushing No.4 key after selection and push No.1 key for cancellation.

13-1-4 Analog output (DAC) voltage (current) check

It is a mode to check analog output voltage (current).

Analog high output setting value is displayed to meter display unit.

Check output voltage (current) with the equipment of digital multi meter to the outside.

When there is change in analog high output setting value, output of voltage (current) is conducted based on display value.

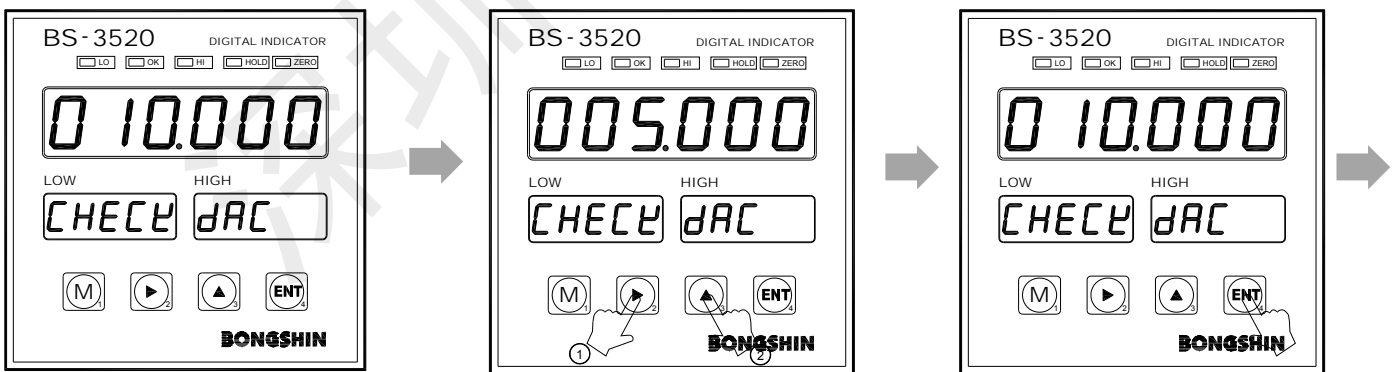
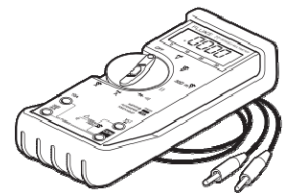

6 It is a mode to check analog output voltage (current). Digital multi meter shall be equipped to output terminal.

7 Output of voltage (current) is conducted from analog output terminal based on its value when the change in value is conducted with the use of No.2 and No.3 key.

8 It moves onto next stage when pushing No.4 key and push No.1 key for the cancellation.



- Check mode is displayed only when DAC is selected from **13-1-3 Optional output (DAC, BCD) selection mode**.
- For range of setting value change, setting is available within -199999 ~ 999999. (initial value is linked to analog Hi output setting value. Initial value is set as 10.000 at the forwarding)
- In case of checking DAI Analog Output (current), output is no conducted even when (-) value is set.

13-1-5 BCD output check

It is a mode to check BCD output.

BCD of associated digit value is output accordingly with the input value of meter display unit.

For instance, 10^0 digit is output with the input of 000001 and 000002. 111111, 222222, 234985.....

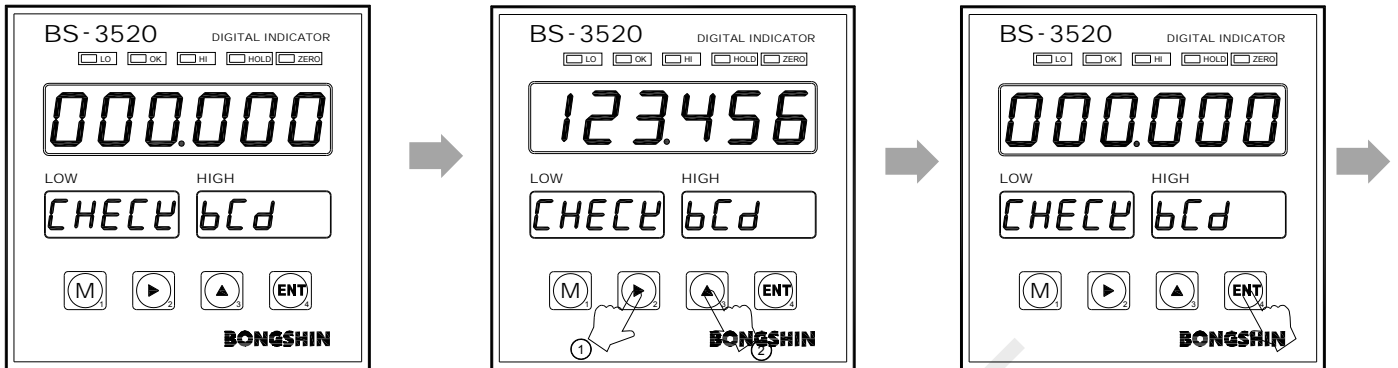

9 It is a mode to check BCD output. Device to use shall be checked through connection.

10 Output of changed value is conducted from BCD output terminal when there is a changed in value with the use of No.2 and No.3 key.

11 It moves onto next stage when pushing No.4 key and push No.1 key for cancellation.

- Check mode is displayed only when BCD is selected from **13-1-3 Optional output (DAC, BCD) selection mode.**
- For range of setting value change, setting is available within -199999 ~ 999999. Decimal point and (-) output are also available. (initial value is set as 000.000)

13-1-6 Initialization Mode

Various settings of data are initialized.

All settings including calibration, function setting, optional output setting, and others are initialized.

Take caution since calibration setting is also initialized.

In case of conducting actual load calibration, dead weight may be necessary upon recalibration.

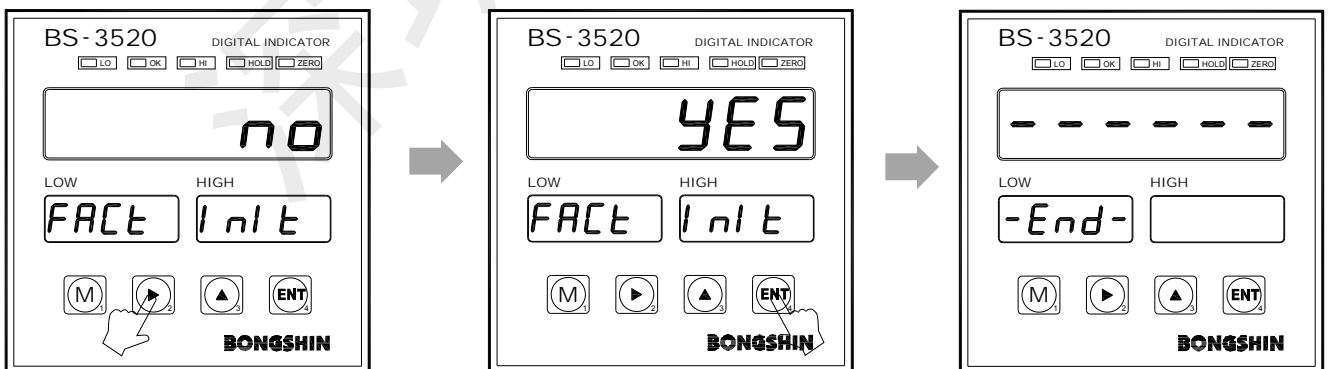

12 Select whether or not to conduct initialization with the use of No.2 and No.3 key. Select Yes for initialization and No for no initialization.

13 Initialization is conducted when pushing No.4 key under Yes status. No initialization is conducted when Pushing No.1 key.

14 Check mode has been completed and it is turned into measurement mode.

- Entry to check mode is available even under key lock status.
- Actual load calibration is initialized and it returns to factory forwarding status.

14. Key Lock Mode

It is a key lock mode.

It is a mode to protect calibration & zero setting and function item setting value.

Entry to relay setting value change mode is available only.

14-1 Key lock method

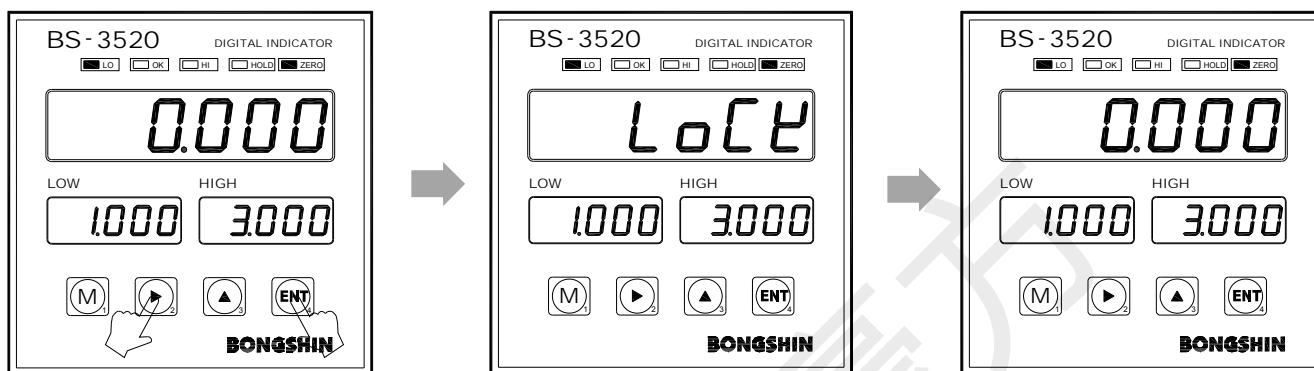

1 Push No.2 key while pushing No.4 key.

2 LoCK is displayed and it is turned into key lock mode.

14-2 Key lock cancellation

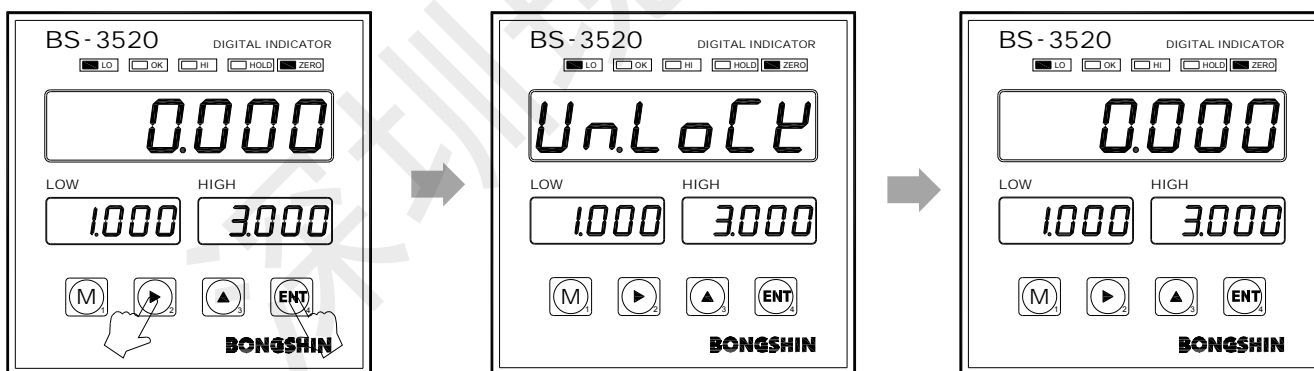

1 Push No.2 key while pushing No.4 key.

2 UnLoCK is displayed and key lock is cancelled.

15. Repair

15-1 Error message

In case of error display, please take measure accordingly with the countermeasures.

Error display	Cause	Countermeasure
LoCK	Key lock function is operated.	Conduct key lock cancellation with the use of 14-1 KEY Lock cancellation method.
Err0	<ol style="list-style-type: none"> 1. Dead weight value is small. 2. Voltage of span calibration conducted point is either same or lower than zero point. 3. There is no change in load cell output or change upon small dead weight value. 	<p>This error is occurred under calibration status. Calibration shall be conducted using appropriate dead weight.</p> <p>Check the disconnection of load cell since (-) output of load cell is conducted.</p>
Over	Load cell output value is high.	<p>This error is occurred when checking load cell output voltage of check mode.</p> <p>Abnormality of load cell shall be checked since load cell output is 35mV or higher. It shall be less than 15mV or lower in general.</p>
-Over	Load cell output value is low.	<p>This error is occurred when checking load cell output voltage of check mode.</p> <p>Abnormality of load cell shall be checked since load cell output is -35mV or lower.</p>
999999 199999	It exceeded max range of display value.	<p>It exceeded max range of display that is either -199999 or 999999.</p> <p>Conduct calibration again after checking load cell output voltage and disconnection.</p>

15-2 Load cell inspection

When the load cell in use is instable, following items shall be inspected.

1. Check whether or not load cell terminal is properly connected to the meter.
2. Check whether or not terminal connection within Summing Box and Junction Box is properly conducted.
3. Check whether or not there is mechanical interference.
4. When the zero point value of load cell, namely output value under no load status of load cell, strays off from self-specification range, it may be caused by mechanical transformation by overloading and impact, interference of meter container and structure, damage in inner circuit of load cell, etc.
5. Check whether or not measured resistance between terminals of load cell conforms to the specification (refer to catalogue and report).
6. Measure the insulation resistance between each lead wire (wire in red, white, green, and blue) and earth wire with 50V D.C insulation tester and check whether or not it is higher than 100 MΩ.

15-3 Load cell access diagnosis

Disconnection, wiring defect, and others of load cell cable can simply be checked if you have digital multi meter.

When you don't have digital multi meter, check the load cell output value by referring to

13-1-2 load cell output voltage check.

It is part measured when checking the connection of load cell.

In case of using summing box, same measurement shall be conducted inside the summing box as well.

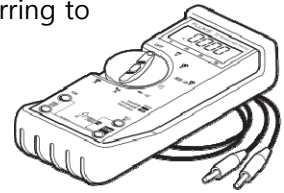

	Diagnosis item	Diagnosis location	Criteria (normal standard)
1	Load cell applied voltage	EXC+ ↔ EXC-	DC 5V
2	Load cell output voltage	SIG+ ↔ SIG-	Within ± 15mV
3	Load cell focused voltage	EXC+ ↔ SIG+	Around DC 2.5V
		EXC- ↔ SIG-	Around DC 2.5V

15-4 Pattern of display character

Below table illustrates the display pattern of BS-3520.

0		D		Q	
1		E		R	
2		F		S	
3		G		T	
4		H		U	
5		I		V	
6		J		W	
7		K		X	
8		L		Y	
9		M		Z	
A		N		±	
B		O		.	
C		P		-	